



V500

AW-RATED UPVC VINYL SERIES

Project-in Casement | Project-in Hopper | Tilt/Turn | Fixed









 **Product Material**
uPVC Vinyl

 **Frame Depth**
3 1/4"

 **Rating**
Project-In Casement: AW75
Project-In Hopper: AW75
Tilt/Turn: AW75
Fixed: AW100



Fieldhouse Dinkytown
Minneapolis, MN
Developer: GD Up Minneapolis LLC
Architect: Cuningham Group Arch.
Contractor: Ironmark Building Co.
Dealer: ProSource Bldg. Supply

 Design Pressure Casement: 75 Hopper: 75 Tilt/Turn: 75 Fixed: 100	 U-Value Casement: 0.19-0.31 Hopper: 0.19-0.30 Tilt/Turn: 0.16-0.31 Fixed: 0.14-0.31
 Air Infiltration Casement: <.10 Hopper: <.10 Tilt/Turn: <.10 Fixed: <.10	 SHGC Casement: 0.07-0.29 Hopper: 0.07-0.30 Tilt/Turn: 0.10-0.49 Fixed: 0.12-0.50
 Water Resistance Casement: 12 Hopper: 12 Tilt/Turn: 12 Fixed: 12	 CR Casement: 45-79 Hopper: 42-77 Tilt/Turn: 45-78 Fixed: 45-78
 OITC Casement: Contact Quaker Hopper: Contact Quaker Tilt/Turn: Contact Quaker Fixed: Contact Quaker	 STC Casement: Contact Quaker Hopper: Contact Quaker Tilt/Turn: Contact Quaker Fixed: Contact Quaker

Thermal Value Ranges based on multiple Low-E/Argon I.G. combinations

FEATURES:

- ▶ Outstanding AW-Rated structural performance for a uPVC vinyl window
- ▶ Architectural grade, reinforced uPVC vinyl frame
- ▶ Industry leading air, water, and structural performance
- ▶ Fusion welded sash and frame corners
- ▶ 1", 1 3/8", and 1 1/2" Insulating Glass
- ▶ Clean exterior appearance
- ▶ Operating Casement models include Project-In and Tilt-and-Turn models
- ▶ Up to 48" wide and 96" height for Casement models
- ▶ Continuous frame capabilities for multi-unit sets
- ▶ White or Sandstone uPVC vinyl (exterior/interior)
- ▶ Textured laminate options for exterior and interior
- ▶ Complete group of complimenting uPVC hinged and sliding doors available



V500

AW-RATED UPVC VINYL SERIES

Project-In Casement

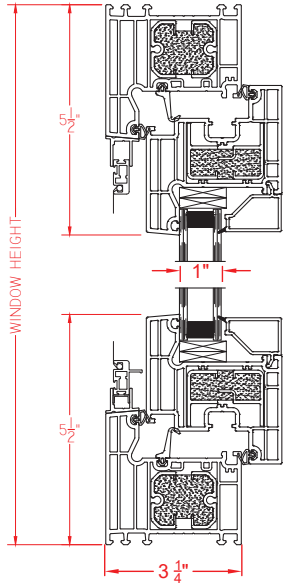

Tilt/Turn

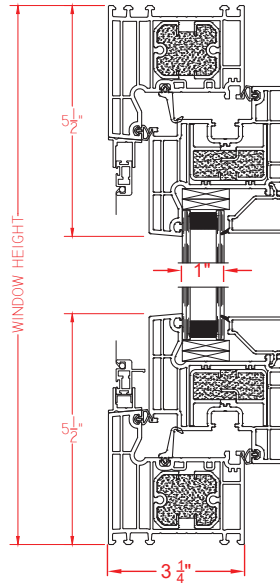

Project-In Hopper

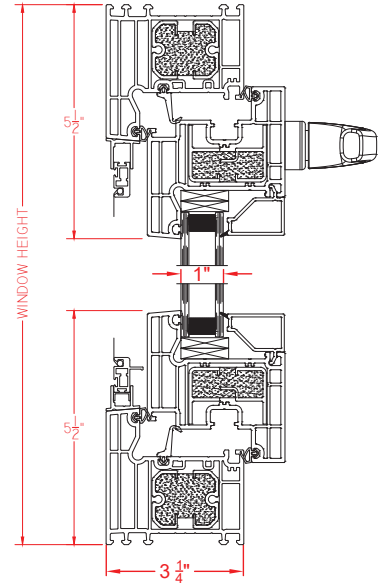

Fixed

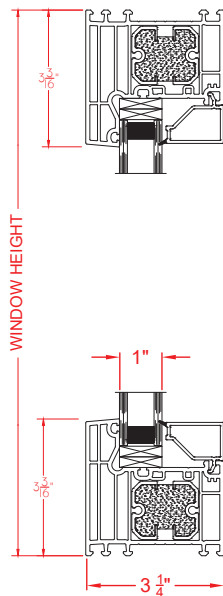

Fixed over Hopper

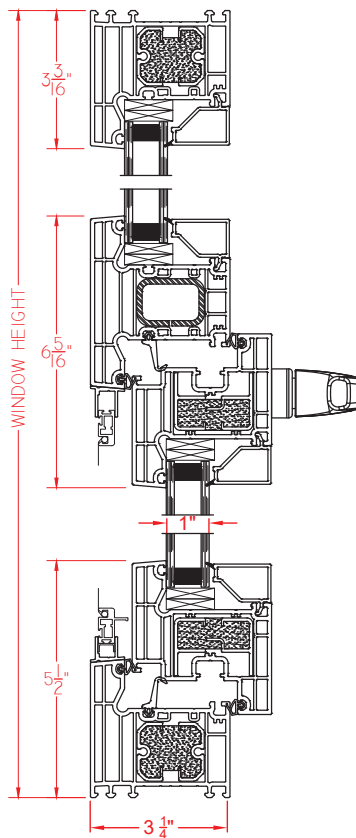

QuakerCommercialWindows.com
1-800-347-0438
Commercial@quakerwindows.com