



M600

COMMERCIAL ALUMINUM SERIES

Casement | Project-Out | Fixed









 **Product Material**
Aluminum

 **Frame Depth**
3 1/4"

 **Rating**
Casement: AW70
Project-Out: AW70
Fixed: AW80

Midtown Plaza
Champaign, IL
Developers: RI Berkley LLC
Architect: Trachtenberg Architects
Contractor: West Builders
Dealer: Pinnacle Installations



 Design Pressure Casement: Up to 70 Project-Out: Up to 70 Fixed: Up to 70	 U-Value* Casement: .32 - .57 Project-Out: .33 - .59 Fixed: .18 - .50
 Air Infiltration Casement: <.10 Project-Out: <.10 Fixed: <.10	 SHGC* Casement: .11 - .54 Project-Out: .11 - .54 Fixed: .13 - .68
 Water Resistance Casement: Up to 15 Project-Out: Up to 15 Fixed: 12	 CR* Casement: 29 - 47 Project-Out: 29 - 46 Fixed: 31 - 60
 OITC^x Casement: 23 - 34 Project-Out: 33 - 34 Fixed: 27 - 33	 STC^x Casement: 29 - 43 Project-Out: 41 - 43 Fixed: 30 - 41
<p>*-Ranges based on multiple Low-E/Argon I.G. combinations ^x-Ranges based on multiple I.G. combinations</p>	

FEATURES:

- ▶ Architectural grade aluminum frame
- ▶ Thermally-enhanced design with pour-and-debridge technology
- ▶ 3" narrow sitalines
- ▶ With or without Integral Nailing Fin
- ▶ 1" insulating glass
- ▶ Casement and Project-Out operating models
- ▶ Roto or Cam-handle hardware
- ▶ Standard High-Performance 2604 Powder Paint Finish (an FGIA Specification)
- ▶ Optional upgrade to 2605 Powder Paint Finish (an FGIA Specification)
- ▶ 30+ "Quick-Pick" colors, with unlimited custom colors available.
- ▶ Impact rated versions (M700 Series)

www.QuakerCommercialWindows.com

Information listed is deemed accurate as of date shown. Quaker Windows reserves the right to change or discontinue any product, feature or option without notice.

May, 2026 V6



M600

COMMERCIAL ALUMINUM SERIES

Casement Roto (AW70)

Test size = 48" x 84"

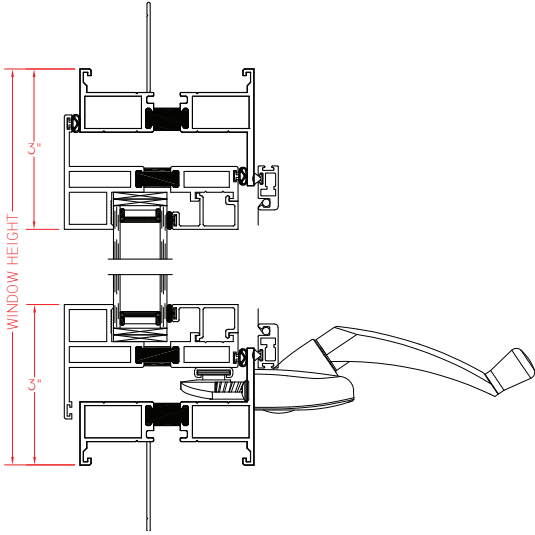

Casement Cam Handle (AW70)

Test size = 36" x 96"

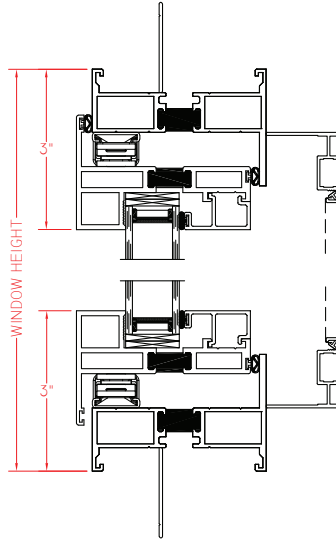

Fixed (AW40 to AW80)

Test size = 60" x 60"

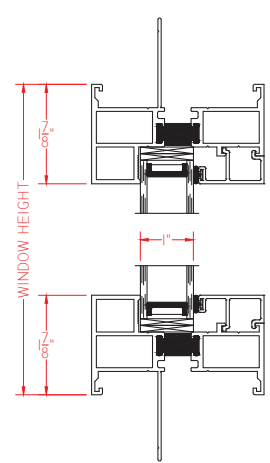

Project-Out Roto (AW70)

Test size = 60" x 36"

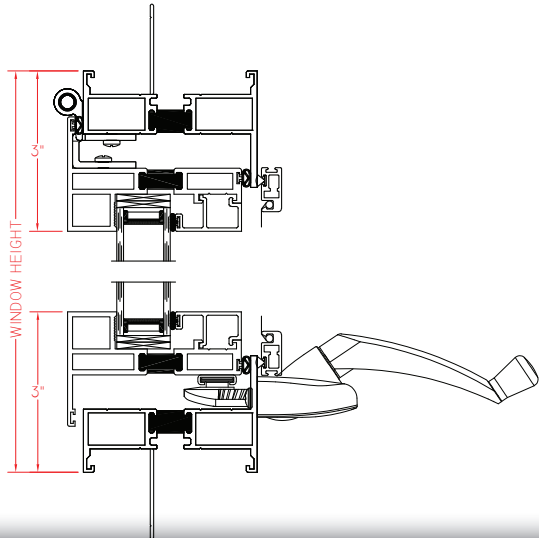

Project-Out Cam Handle (AW70)

Test size = 60" x 36"

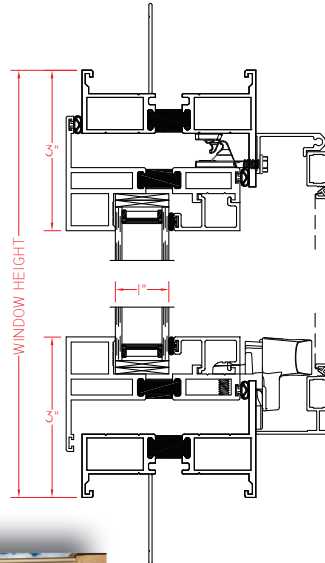

All drawings shown with nailing fin.

All ratings listed are NAFS certified.



Hamilton Tower @ Providence Point
Pittsburgh, PA
Owner: Baptist Home Society Inc.
Architect: RLP Architects
Gen. Cont: P.J. Dick Inc.
Dealer: Specified Systems



QuakerCommercialWindows.com
1-800-347-0438
Commercial@quakerwindows.com