

# CityLine/CityVu EdgeLine/EdgeVu M-Series (M2055) MultiSlide 90° Door Installation Guide

IG-087 REV. 03/24 1.3



## CityLine CityVu

Scan Here for a Digital Version of the  
Installation Guides in English.

Quartz Luxury Windows & Doors:  
[www.quartzluxurywindows.com](http://www.quartzluxurywindows.com)



## EdgeLine EdgeVu

Scan Here for a Digital Version of the  
Installation Guides in English.

Quaker Residential Windows & Doors:  
[www.quakerresidentialwindows.com](http://www.quakerresidentialwindows.com)

Not Available for Commercial.



Para ver las instrucciones en Espanol, escanea aqui.

If this set of instructions does not match your installation method or the wall conditions of the job site, please check our website listed below for other options, or call Quaker Customer Service for additional information.







Quaker Window Products  
504 U.S. Hwy 63 South  
Freeburg, MO 65035  
(800) 347-0438  
[www.quakerwindows.com](http://www.quakerwindows.com)



## CityLine/CityVu, EdgeLine/EdgeVu M-Series (M2055) MultiSlide 90° Door Installation Guide

**Read these instructions completely before starting any installation.** Failure to install and maintain our product according to these instructions may void any product warranty. These are generic instructions intended to cover most common situations, which may not be appropriate for all installations due to building design, construction materials, or methods used and/or building or site conditions. Please visit our website at [www.quakerwindows.com](http://www.quakerwindows.com) or call 1-800-347-0438 for additional information. Inspect all units for any damage or defects prior to installation.

### Tools required by installer:

Safety Glasses		Utility Knife	
Drill/Driver		Caulk Gun	
Level		Tape Measure	
Hammer		J-Roller	
Putty Knife		Staple Gun	
Phillips #2 Screwdriver		Metal Cutting Saw	
Torx #20 Bits			

### Materials required by installer:

Foam Backer Rod		Minimally Expanding Spray Foam	
Shims (waterproof)		C920 Silicone	
Flashing Tape (Self-Ahering)		Water Resistant Barrier/House Wrap (WRB)	
Fasteners		IPA Alcohol	
		Drip Cap	

## ⚠ WARNING

### Tools

- Follow manufacturer's instructions for safe operation of tools, and ladders/scaffolding. Always wear safety glasses. Failure to do so could result in injury, product or property damage.

### Handling

- Do not store units outside, or in a hot environment. Doing so could result in product damage.
- Do not carry flat.** Doing so could result in product damage, injury, or property damage.
- Stack units as straight as possible to avoid bowing. **Do not lay flat!**

### Glass

- If broken, glass can fragment causing injury. All Quaker products are available with safety glass. In many areas, local building codes require safety glass in certain locations and/or applications. Quaker door products are provided with safety glass per industry standards. Consult your local building codes for more definitive information.

### Fastening

- Metal fasteners and components could corrode when used with preservative-treated lumber. Use approved fasteners and components to fasten window or door. Failure to do so could cause a failure resulting in injury, product or property damage.
- Fastener must attach to a structural framing member with 1 1/2" minimum fastener embedment, or minimum 3 full threads with a minimum 5/16" head as products were tested with.
- Quaker does not supply anchorage/fastener calculations, and is not responsible for determining structural adequacy of the anchorage and fasteners used to install our products, or the openings into which they are installed.**
- Do not over drive screws or nails.** Doing so could result in product damage.

### Notice

- The suggested overhang of the structure should match the height of the unit being installed.

**CAUTION****Installation**

- Maintain a minimum of 1/4" between the window or door frame and exterior finish materials. Failure to do so could result in product or property damage.
- Nailing flanges and drip caps (integral or applied) **do not** take the place of window and door flashing. All windows and doors must be properly flashed and sealed with material compatible sealant for protection against water and air infiltration around the entire perimeter. Failure to do so could result in product or property damage.
- Place shims around perimeter as required. Door must be properly shimmed. Failure to do so could affect operation and product performance and could result in product damage.
- Live or dead loads transferred into our product can affect functionality, damage frame joinery or cause glass failures. Dead loads such as upper levels, roof, etc. Should be constructed before window or door is installed.
- Loads shall be designed to withstand the most critical effects of load factors and load combinations as required by the building code. (Loads are including but not limited to Live, Dead, Collateral, Auxiliary, Thermally induced, Seismic, etc.)
- Maximum vertical deflection of the header under all Load combination should not exceed 1/8".
- **Do not** drill through or into door sill to install alarm wires.

**Sealing**

- Follow instructions of foam, sealant, and flashing manufacturers regarding safety, material application, compatibility, and periodic maintenance for continued weather resistance of their products. Failure to do so could result in product or property damage. **DO NOT** overfill between the frame and opening.
- Minimally expanding foam insulation must be compliant with AAMA 812-19.
- Quaker requires 100% silicone (ASTM C920 compliant) neutral cure only sealant. Always clean all areas where sealant will be applied. Failure to do so could result in product or property damage.
- Flashing tape must meet ASTM-D779 performance requirements.

**Joining**

- Do not join any window or door to any window or door not designed for joining. Joined windows and doors must be individually supported in the opening. Failure to do so could affect operation and product performance and could result in product or property damage.

**Cleaning**

- Acid solutions used for cleaning will damage glass, fasteners, hardware, and metal flashing. Protect these products and follow cleaning products manufacturers instructions. If acid contacts the window or door, wash all surfaces immediately with clean water.
- **Do not** use razor blades to clean glass surface. Glass damage could result.
- Clean glass using liquid glass cleaner.
- Clean frame, sash, panels, and insect screens using mild detergent and warm water with a soft cloth or brush.

**IMPORTANT**

- Buildings constructed prior to 1978 could contain lead paint which could be disturbed during window or door replacement. For more information on proper management of lead paint, go to: [www.epa.gov/lead](http://www.epa.gov/lead)
- Care must be taken to properly recycle or dispose of old materials. Any recyclable materials should be separated from non-recyclable or hazardous materials. Please consult with local or state authorities regarding proper disposal of non-recyclable or hazardous materials

**!** **WARNING:** This product can expose you to chemicals including titanium dioxide or methanol, which are known to the State of California to cause cancer and birth defects or other reproductive harm. For more information go to [www.P65Warnings.ca.gov](http://www.P65Warnings.ca.gov).

**!** **WARNING:** Drilling, sawing, sanding or machining wood products can expose you to wood dust, a substance known to the State of California to cause cancer. Avoid inhaling wood dust or use a dust mask or other safeguards for personal protection. For more information go to [www.P65Warnings.ca.gov/wood](http://www.P65Warnings.ca.gov/wood).

1











## Verify Header Support

Ensure the roof over the door system is full supported. Take into account the weight of any material over the door system, because this may cause deflection. No more than 1/8" deflection is allowed for install. Confirm that all material and fasteners are adequate for the load requirements.

If you have any questions please feel free to call us at Quaker Windows.

Phone : 1 (800) 347 – 0438.

2

QUAKER						STANDARD OPERATING PROCEDURE		
TITLE						DATE	ASSOCIATE	
Packing List For 4 Panel Door						3/28/2023	J Loehner	
SOPI#	RMS.VS	VERSION	1.0	DEPT	551	SERIES	RMS VS Packing List	
<input type="checkbox"/>	(M25274)	Sill Pan For Opening					1	
		* If Door calls out over 240" need to Splice. Cut in Half. Then would be 2 Pieces. Under 240" only 1 piece.						
<input type="checkbox"/>	(FE_25-7X10-35-D)	Frame Corner Key					4	
<input type="checkbox"/>	(FE_FAST2)	Corner Key Frame Screw					8	
		***Add 4 if Unit is Spliced.						
<input type="checkbox"/>	(FE-13X10-35-200)	Frame Corner Key Narrow					2	
<input type="checkbox"/>	(FE_26X10_200_TC)	Frame Splice Key					2	
		***These should only be sent with Spliced Door Systems						
<input type="checkbox"/>	(M24706)	Frame Jamo Covers					6	
<input type="checkbox"/>	(M24705)	Long Frame Head Covers					2	
<input type="checkbox"/>	(M24705)	Short Frame Head Cover					1	
		***Anything Over 240" will have to add 1 short Cover.						
<input type="checkbox"/>	(M25278)	Sill Covers					3	
		* Make sure 3D Part # TBD is on End of Sill Cover * Supply Weatherstripping Part # TBD						
<input type="checkbox"/>	(9309K06)	Panel Bumper					8	

Before installing your door, unpack all parts and place near the opening. Make sure you have all parts according to the packing slip and check for damaged parts.

3

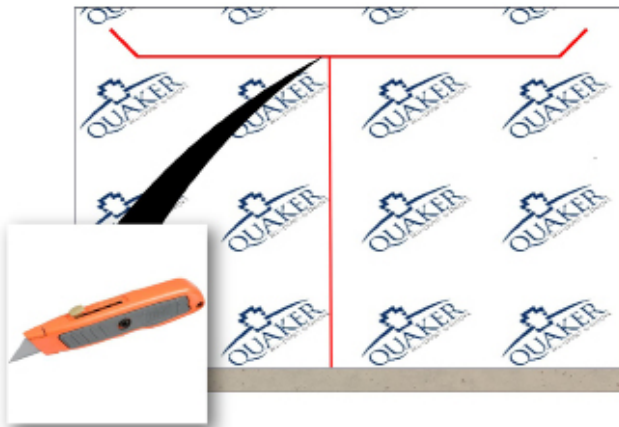

Apply the house wrap according to the manufacturer's instructions and cut T-pattern opening as shown above. Cut top flap angles at 45 degrees and 1" longer than the width of flashing tape being used.

4

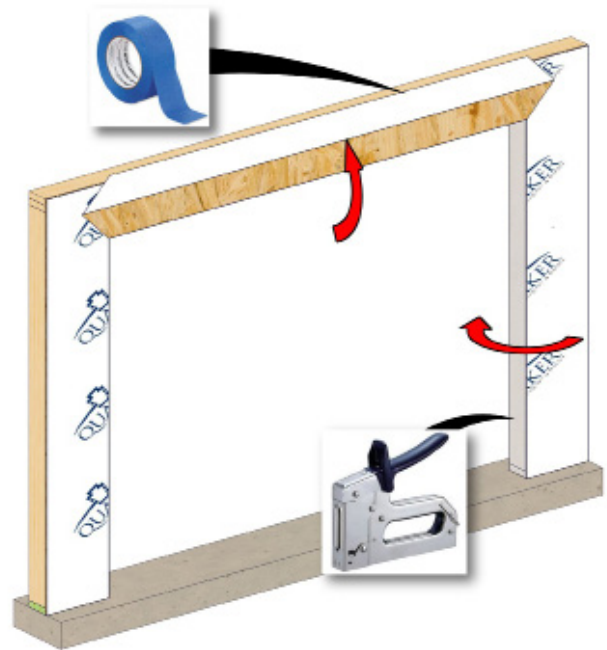

Fold the house wrap around the jambs to the interior and staple it to the interior framing. Fold the house wrap flap up and temporarily tape it in place.

5

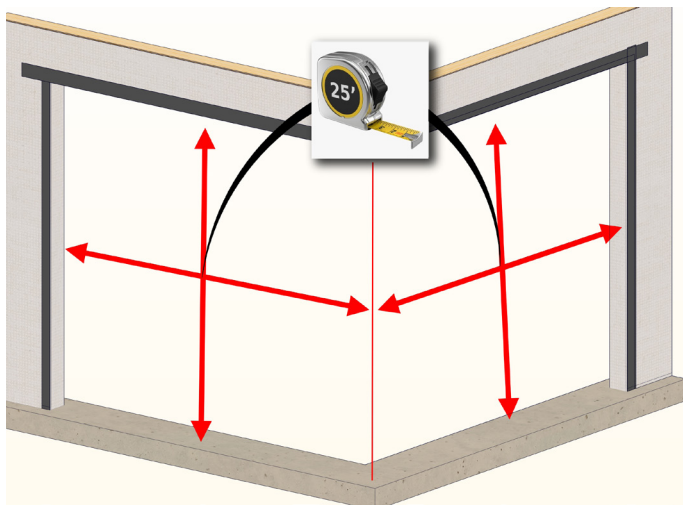

Measure and verify the rough opening is sized correctly. The rough opening should be  $3/4$ " wider and  $1/2$ " taller than the unit. Allow additional space for flashing thickness, installation clips, joining components, and their fasteners.

6

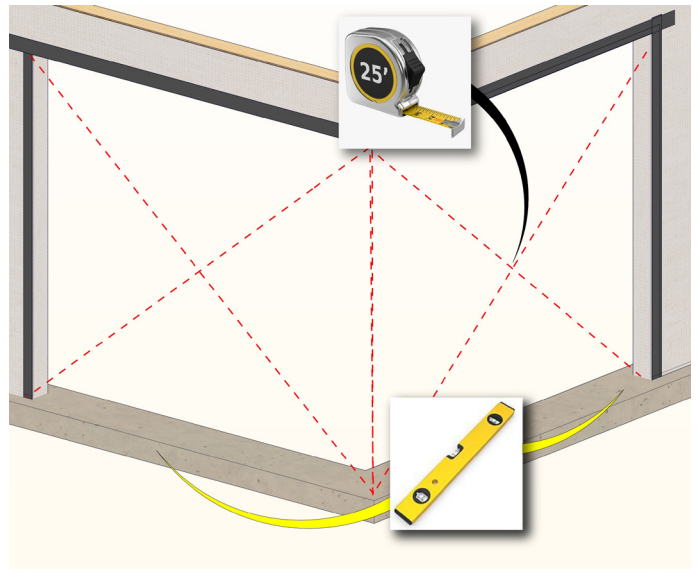

Check that the opening is square. The diagonal measurements need to be within  $1/8$ " of each other. Verify the rough opening is plumb and level.



**The sill plate beneath the unit must be level for proper unit operation.**

7

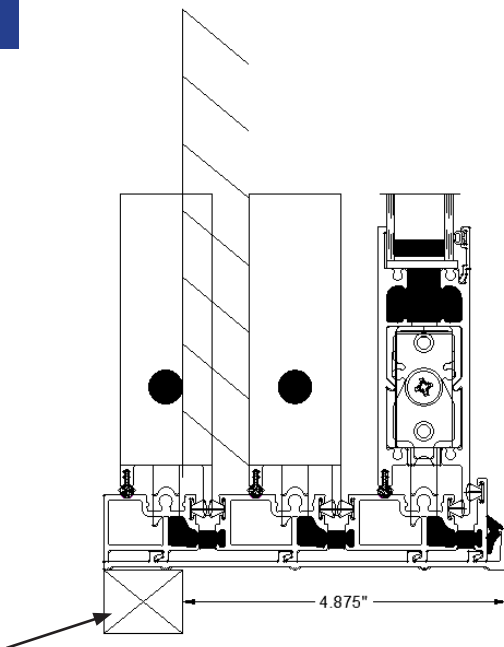

Sill Support by Others

The sill pans will set  $4\ 7/8$ " in from the exterior face of wall framing, where the frame positioning fin sits.



**The unit must be supported the full width and depth of the sill.**

**(Note: For Nail fin installation only.)**

8

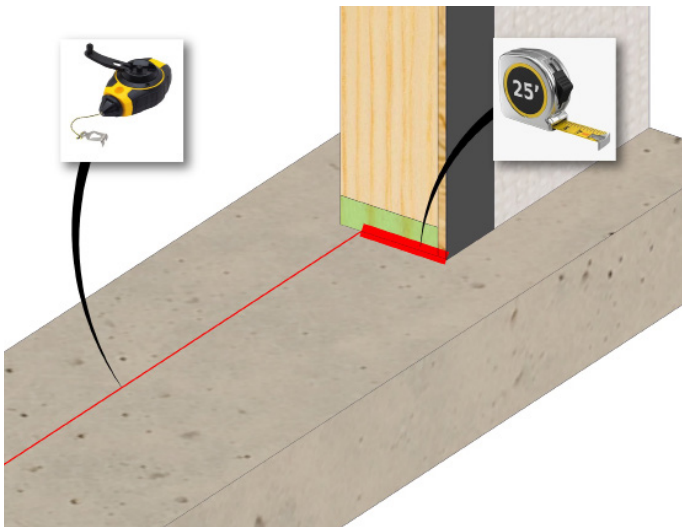

Measure and set a chalk line on the sub floor 4 7/8" in from the exterior wall face. Dry fit the provided sill pan system with the rear upturned leg on this line.  
**The sill condition must be level.**

9

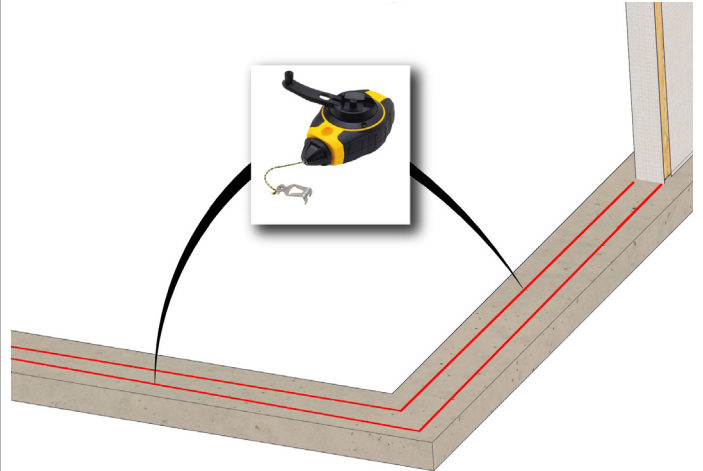

Snap another chalk line, width of sill pan from previous chalk line. This is where the sill pan will sit.

10

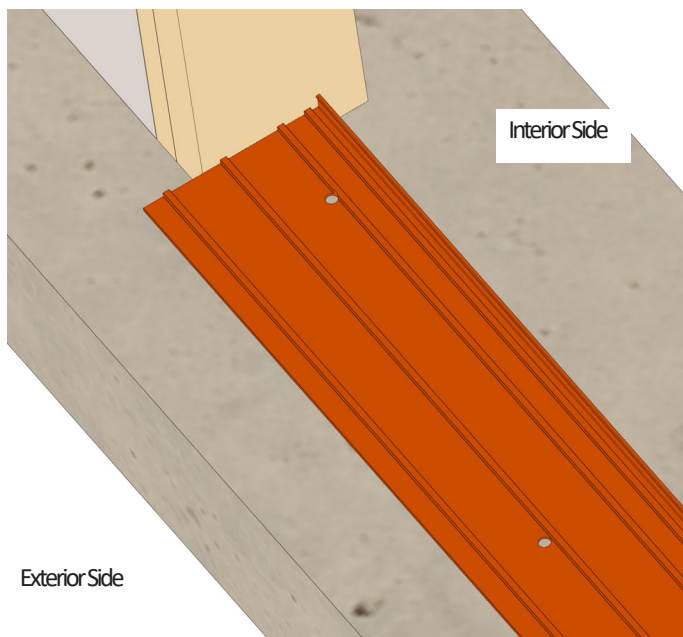

Rough fit the sill pan in place to ensure of proper fitment.

**SILL MUST BE LEVEL!** Quaker first recommends **self leveling concrete**, if not available shim 1' or less, on center.



# FRAME ASSEMBLY

Assemble the frame to make sure sizing is correct.

Multi Tracks - See below - Skip to the step that matches the door which you are wanting to install.

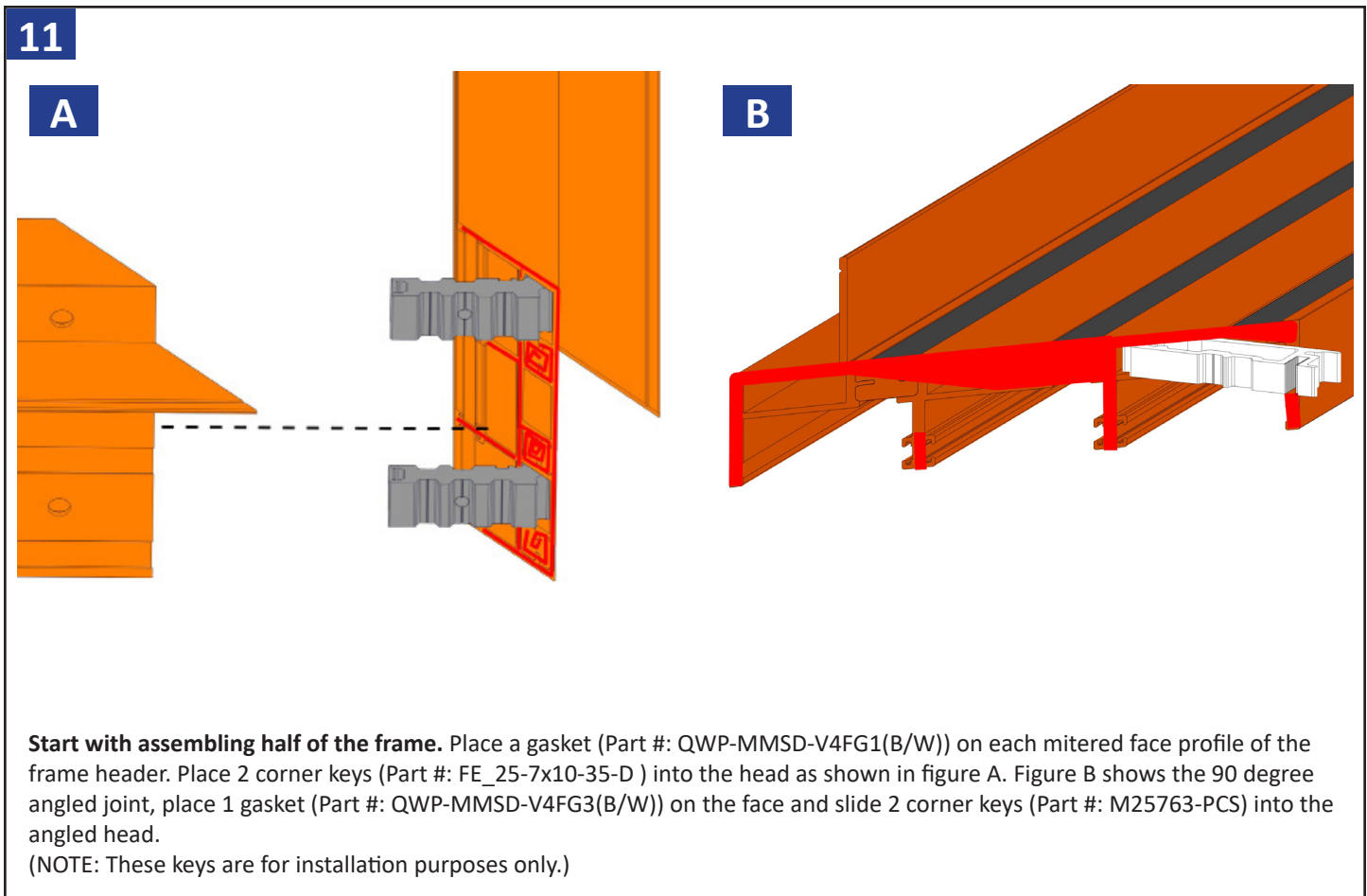

12

## 4 Tracks

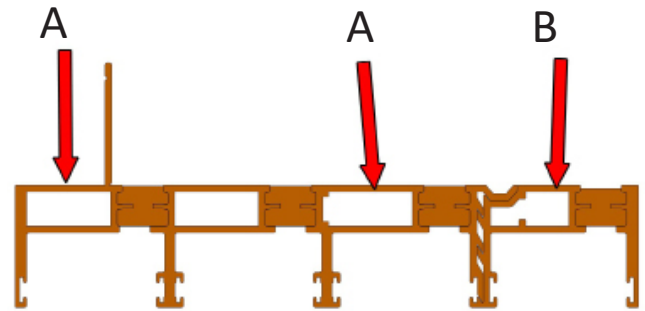
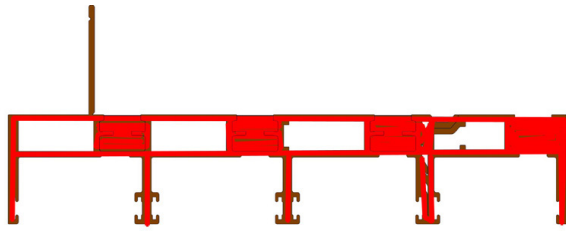

Place a gasket (Part #: QWP-MMSD-V5FG4(B/W)) on each face profile of the frame header. Place 2 of the corner keys (Part #: FE\_25-7x10-35-DT) in both ends of the frame header by arrow (A) and place corner key (Part #: M25762-PCS) by arrow (B). Then join to both frame jambs to head. Trim weather strip flush to both ends. Step 11, figure B shows the 90 degree angled joint, place 1 gasket (Part #: QWP-MMSD-5FG10(B/W)) on the face. Then slide 2 corner keys (Part #: M25763-PCS) A and one (Part #: M25764-PCS) in B as shown above into the angled head.  
(NOTE: These keys are for installation purposes only.)

12

## 5 Tracks

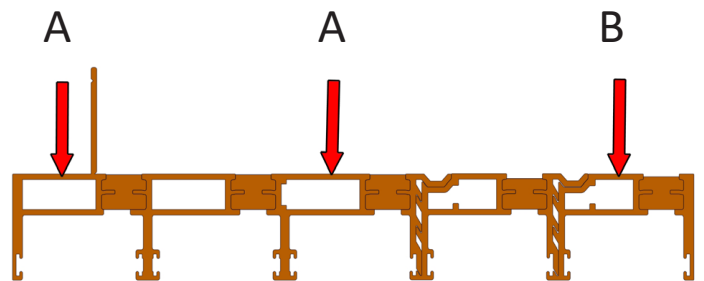
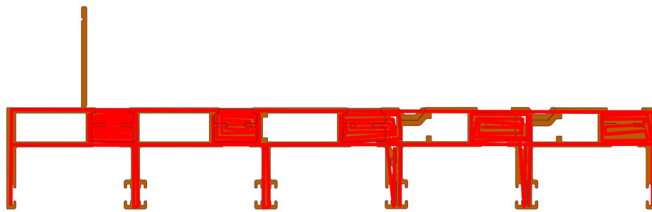

Place a gasket (Part #: QWP-MMSD-V5FG5(B/W)) on each face profile of the frame header. Place 2 of the corner keys (Part #: FE\_25-7x10-35-DT) in both ends of the frame header by arrow (A) and place corner key (Part #: M25762-PCS) by arrow (B). Then join to both frame jambs to head. Trim weather strip flush to both ends. Step 11, figure B shows the 90 degree angled joint, place 1 gasket (Part #: QWP-MMSD-V4FG3(B/W)), and 1 of (Part #: QWP-MMSD-5FG11(B/W)) on the face. Then slide 2 corner keys (Part #: M25763-PCS) A and one (Part #: M25764-PCS) in B as shown above into the angled head.  
(NOTE: These keys are for installation purposes only.)

12

## 6 Tracks

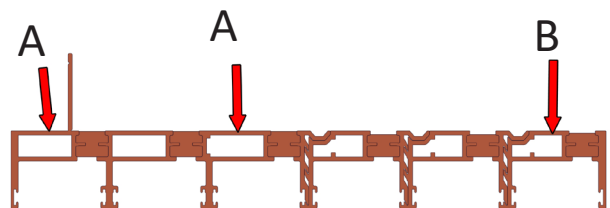
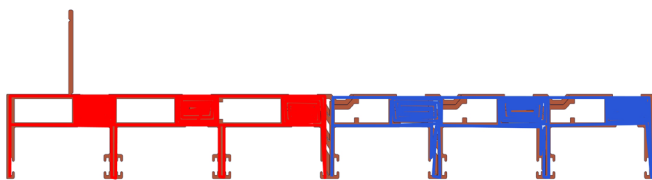

Place gasket (Part #: QWP-MMSD-V4FG1(B/W)) (RED) on the first three tracks, and then place gasket (Part #: QWP-MMSD-V5FG6(B/W)) (BLUE) on the other three tracks. This will go on each face profile of the frame header. Place 2 of the corner keys (Part #: FE\_25-7x10-35-DT) in both ends of the frame header by arrow (A) and place corner key (Part #: M25762-PCS) by arrow (B). Then join to both frame jambs to head. Trim weather strip flush to both ends. Step 11, figure B shows the 90 degree angled joint, place 1 gasket (Part #: QWP-MMSD-V4FG3(B/W)), and 1 of (Part #: QWP-MMSD-5FG12(B/W)) on the face. Then slide 2 corner keys (Part #: M25763-PCS) A and one (Part #: M25764-PCS) in B as shown above into the angled head.  
(NOTE: These keys are for installation purposes only.)



13

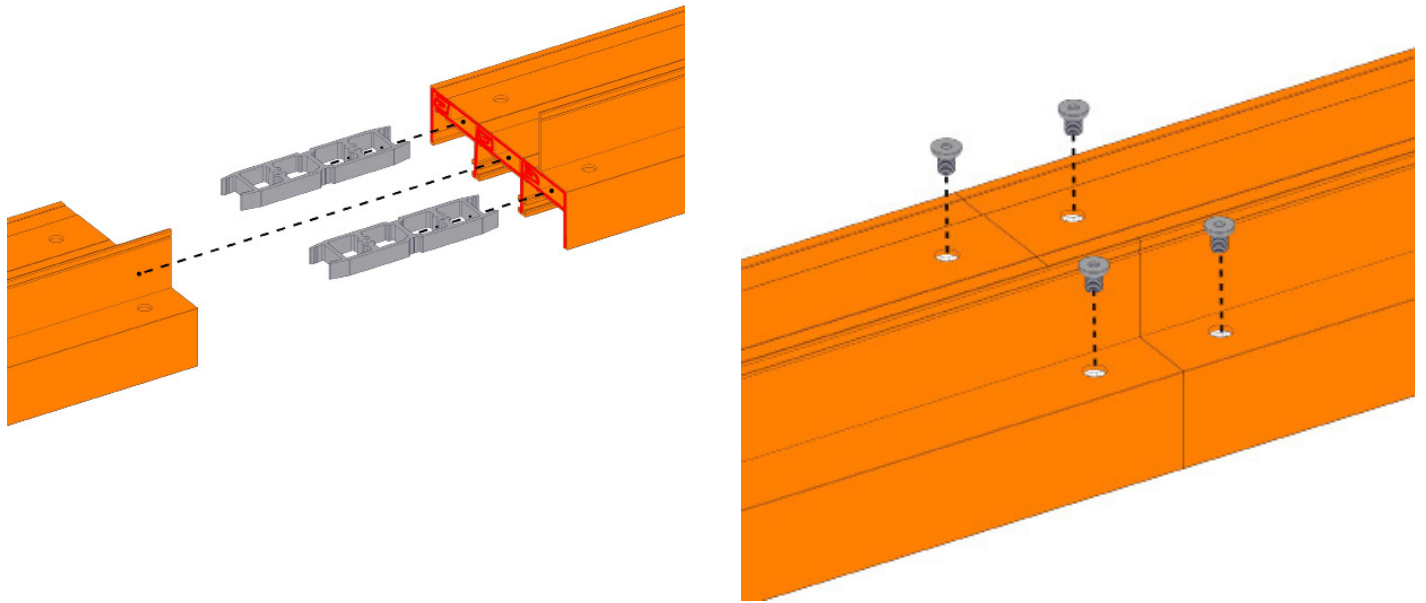

For Two-piece Headers Needing a Splice:

Place a gasket on the face profile of the frame header. Put two splice keys in the first header as shown & screw those in place with 2 or 3 corner key screws. Then slide the other header over the keys and secure in place with 2 or 3 more corner key screws. See below for gaskets and corners keys.

### 3 Tracks

Gaskets -  
QWP-MMSD-V4FG2(B/W)  
Corner keys-  
FE\_26X10\_200\_TC

### 4 Tracks

Gaskets -  
QWP-MMSD-V5FG7(B/W)  
Corner Keys -  
FE\_26X10\_200\_TC and M25762-PCS

### 5 Tracks

Gaskets -  
QWP-MMSD-V5FG8(B/W)  
Corner Keys -  
FE\_26X10\_200\_TC and M25762-PCS

### 6 Tracks

Gaskets -  
QWP-MMSD-V4FG2(B/W) and QWP-MMSD-V5FG9(B/W)  
Corner Keys -  
FE\_26X10\_200\_TC and M25762-PCS

14

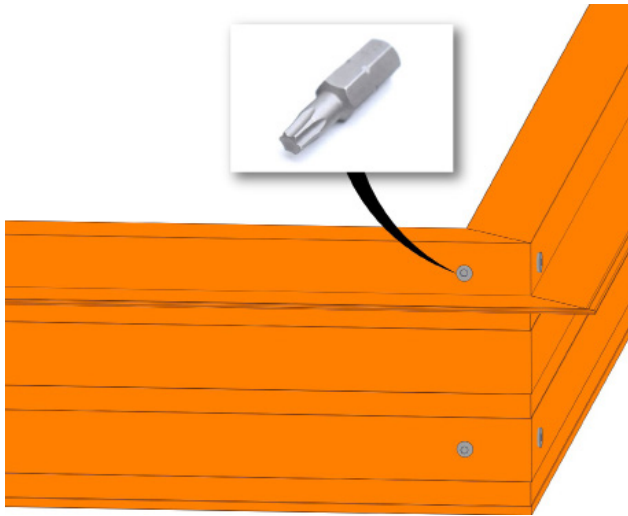

Start 4 screws (Part #: FE FAST2) into the keys at the mitered corner.  
Then tighten all screws.

15

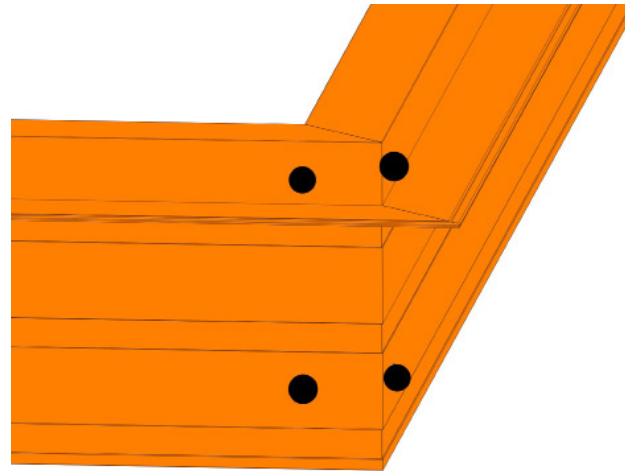

Cover screws with silicone.

16

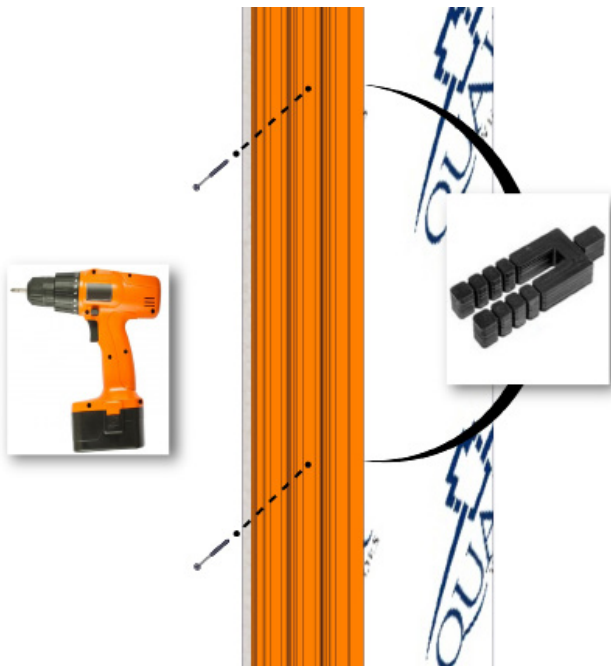

Drill holes through the center track of the header & jambs,  
typically 6" from ends and 24" on center.  
(Drill bit size is based off the screw being used.)

Repeat for the other side.

# SILL PAN INSTALL

17

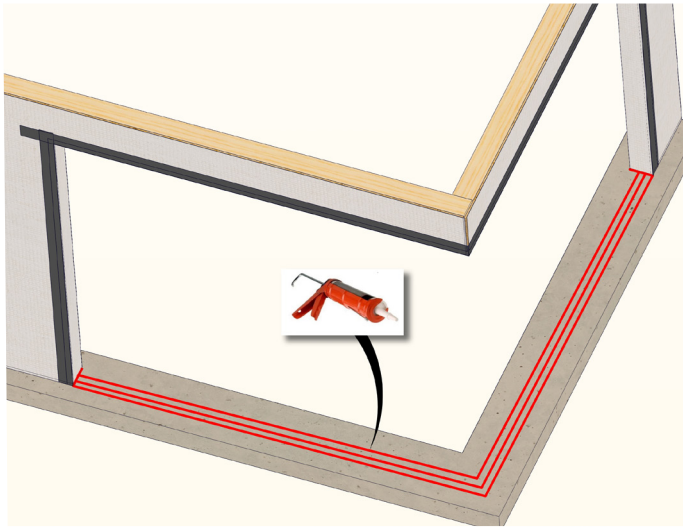

Apply three 3/8" continuous beads of sealant across the entire width of the rough opening sill where the sill pan will sit. Be sure to make a continuous path around the corner as shown above. Apply two 3/8" continuous beads of sealant the width of the pan, 1/2" from each side of opening as shown above.

18

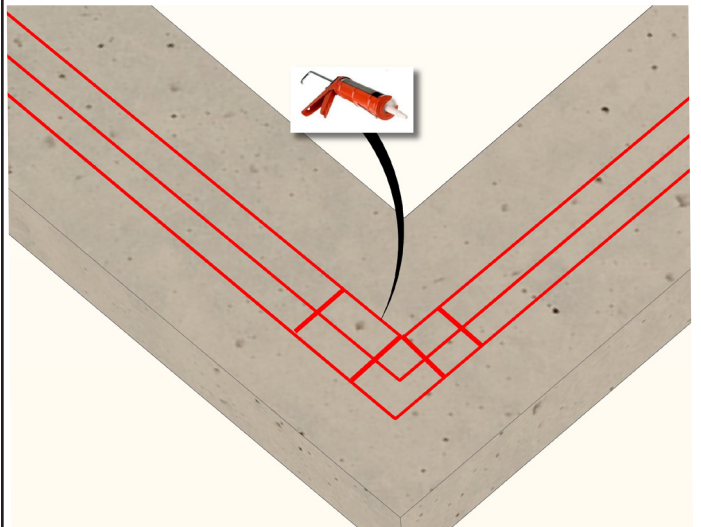

On each side of the 90 degree corner apply 2, 3/8" beads of silicone across the 3 beads of silicone as shown above.

19

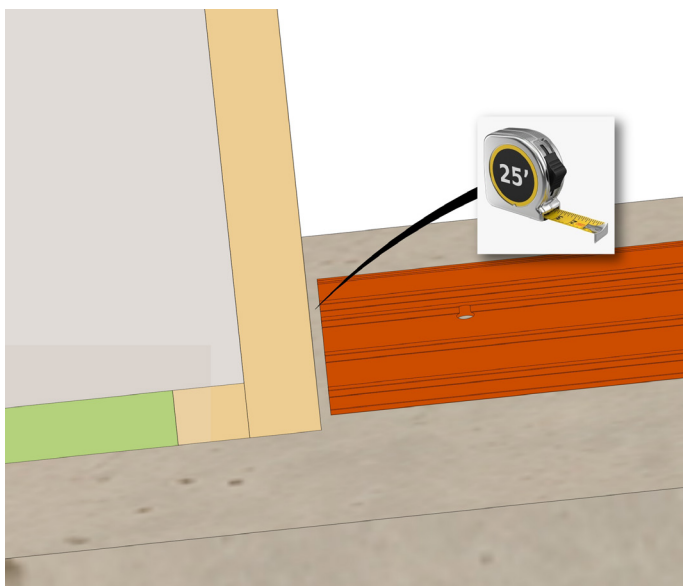

Allow a 1/4" gap between the rough opening and the sill pan.

20

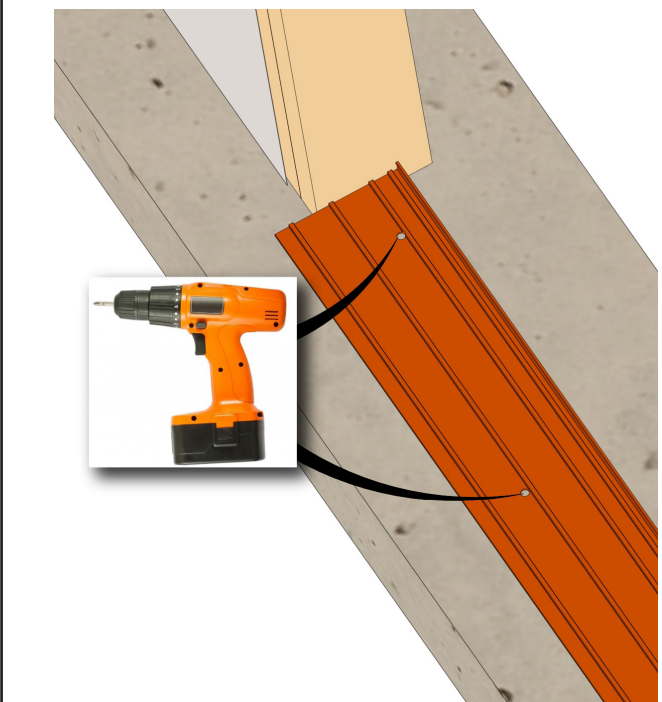

Locate second and third leg and drill holes directly behind them. Drill holes through the sill pan, 3" from each end and then 14" on center for the length of the pan, alternating between the 2 tracks. Blow out the debris on the sill pan. (Drill bit size is based off screw size)

21

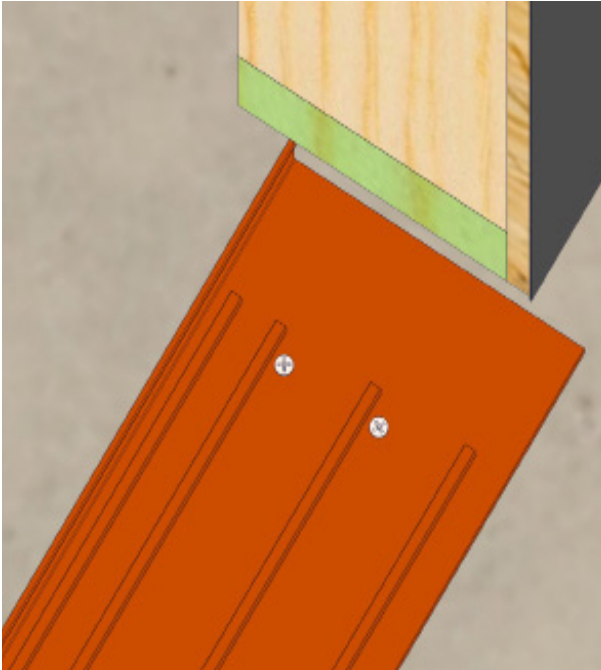

Using a screw with head shorter (less than .150"), screw down the sill pan. Check to make sure sill pan is still level. Shim accordingly.

22

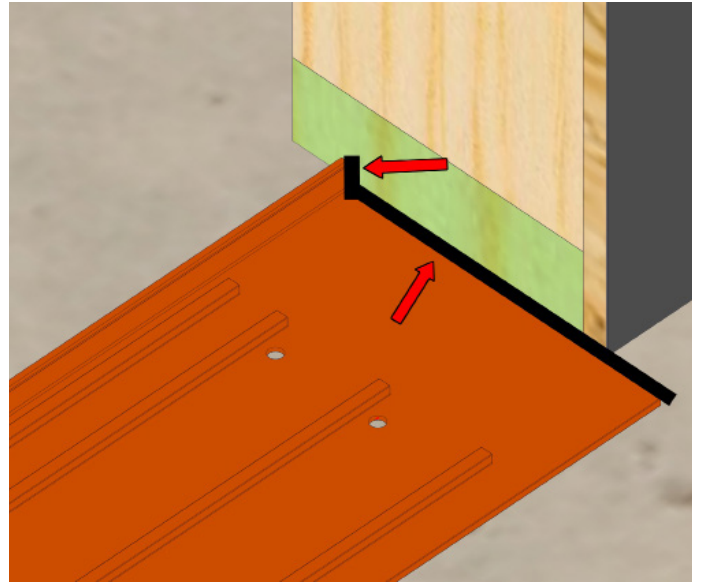

Silicone along the wall and upturned leg. Be sure to tool in the sealant.

Repeat for the other side as well.

23

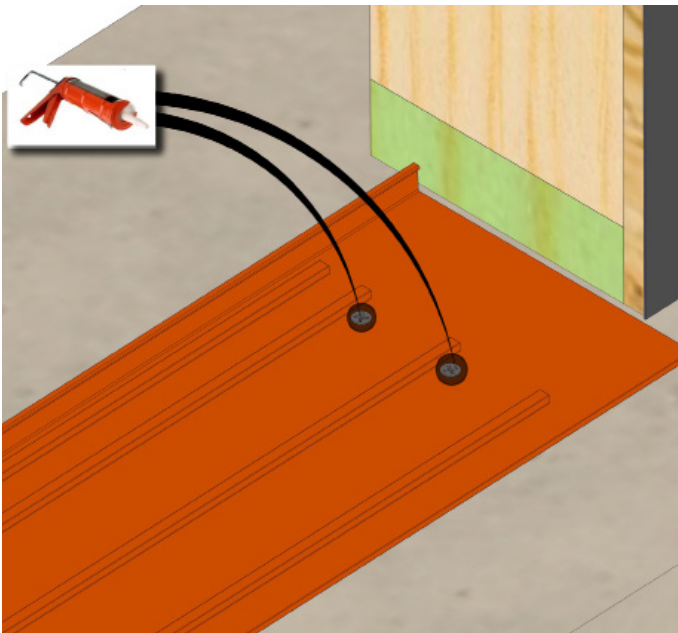

Silicone over all screws and tool in.

24

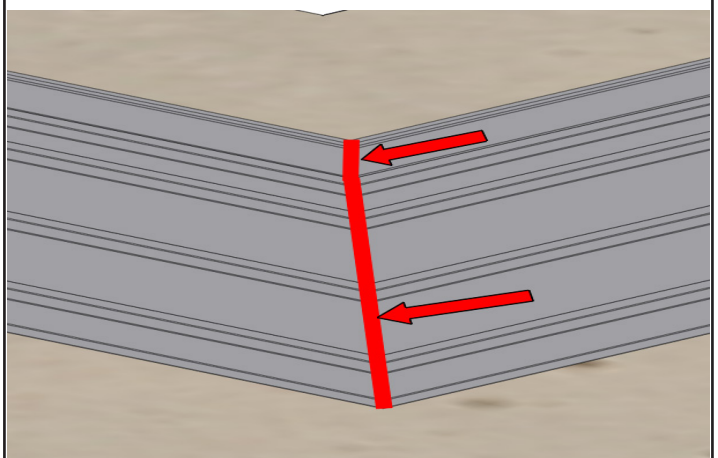

Apply silicone where the 2 sill pans meet, up the interior most leg, and makes a 90 degree corner. Make sure this joint is tight.

# FRAME INSTALL

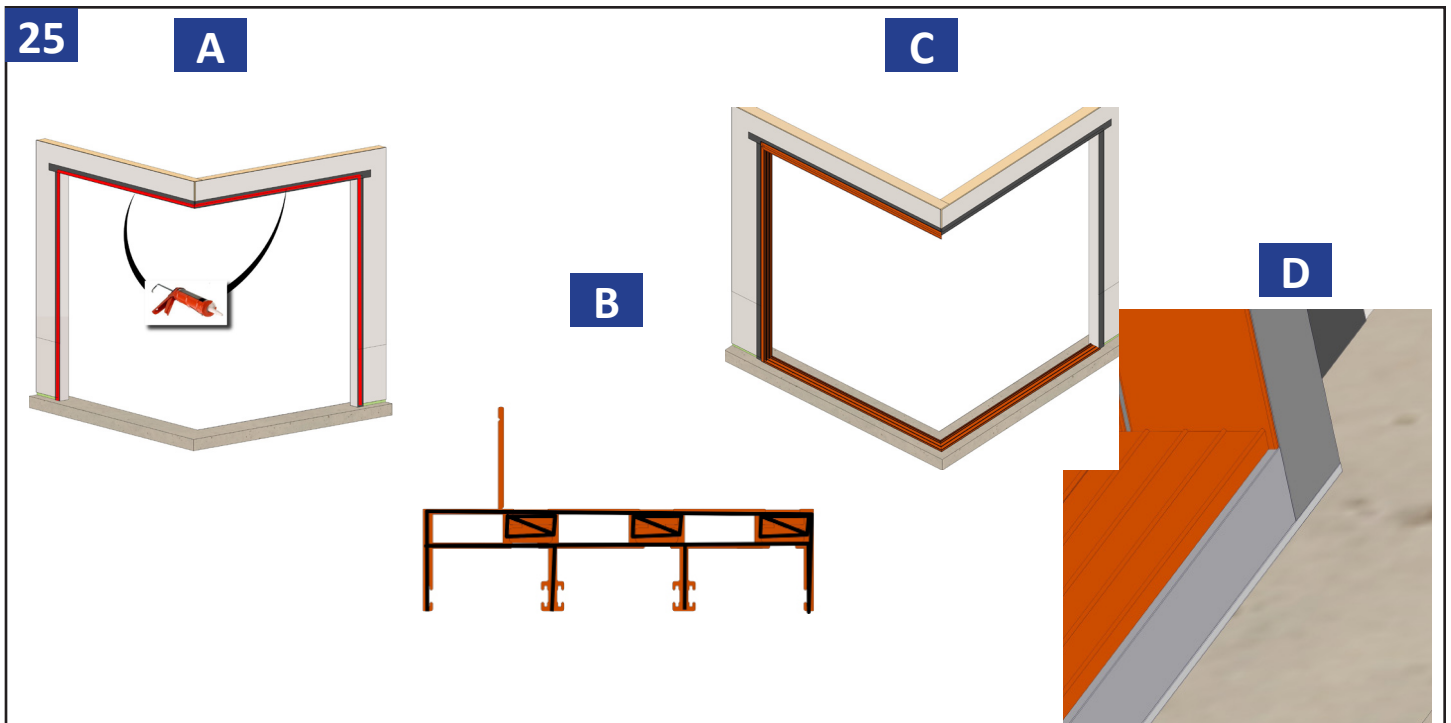

**FOR NAIL FIN INSTALL ONLY!**

(A) Apply a continuous 3/8" bead of sealant around the perimeter of the opening as shown, (B) also trace the bottom of the frame jambs with sealant. (C) Install the frame by sliding in the rough opening with the fin to the exterior side. Set frame onto the sill pan, make the exterior face of the sill pan, (D) flush with the exterior face of the frame.



26

A



B

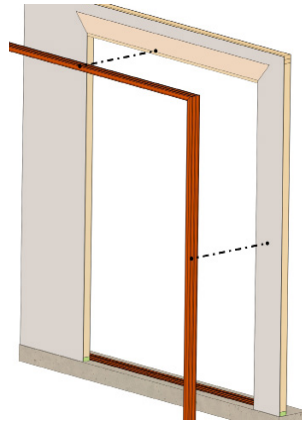

C

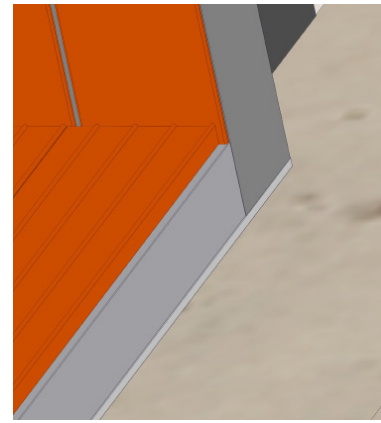
**FOR NO NAIL FIN INSTALL ONLY!**

(A) Trace the bottom of the frame jambs with sealant. (B) From the exterior, install the frame by sliding in the rough opening. (C) Set frame onto the sill pan, make the exterior face of the sill pan, flush with the exterior face of the frame.

27

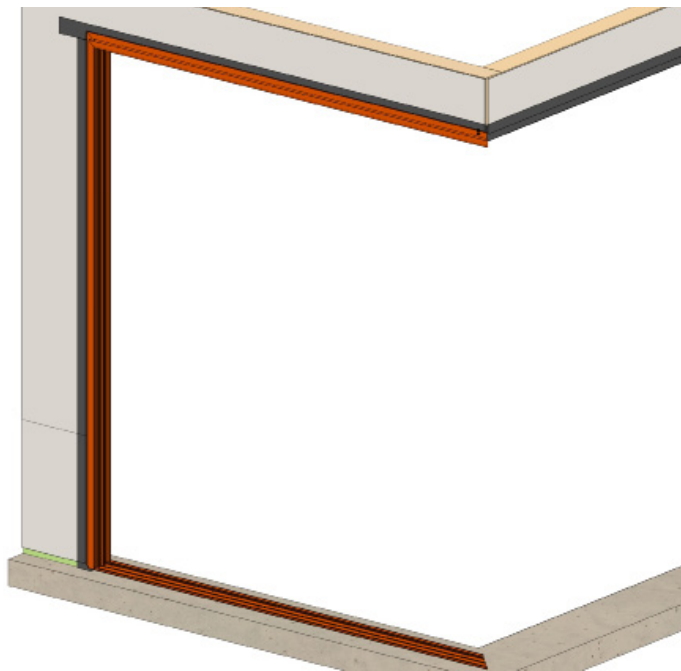

Install half the frame by sliding in the rough opening with the fin to the exterior side. Set the jamb in the sill pan so that the exterior faces of the sill pan. Measure sill pan is in line with the frame jamb.

28

**NAIL FIN ONLY!**

Temporarily secure the frame in the opening at the head corner(s) by tacking a fastener through a slotted hole in the nail fin.

29

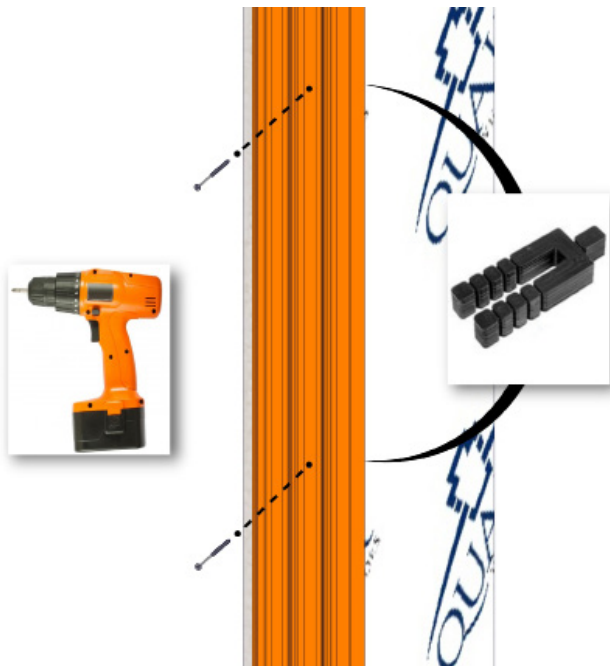

Temporarily set screw just deep enough to hold the frame in place. The screws through the center track of the header & jambs, typically 6" from ends and 24" on center for fasteners.

30

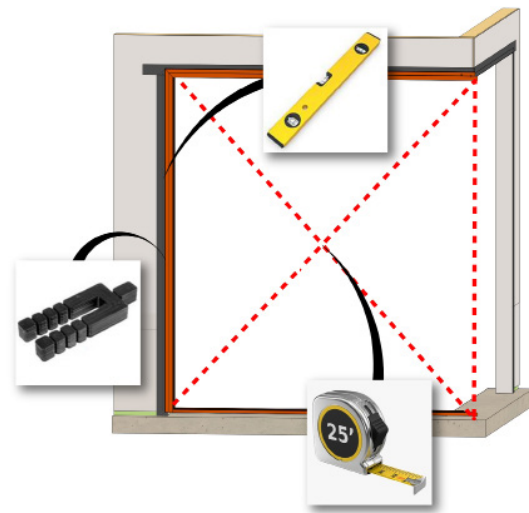

Square, level, and plumb the frame. Adjust shims as needed until diagonal measurements are within 1/8". Shim behind the header and jambs as necessary.

31

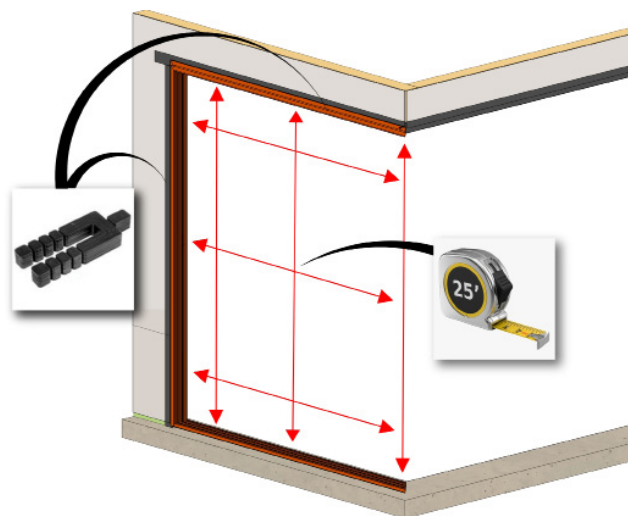

Check that the door frame is not bowed at jambs or head; a string line may be required. The jamb cover can be used to ensure equal spacing between the sill and head. Adjust shims as needed, but verify measurements are within 1/16".

32

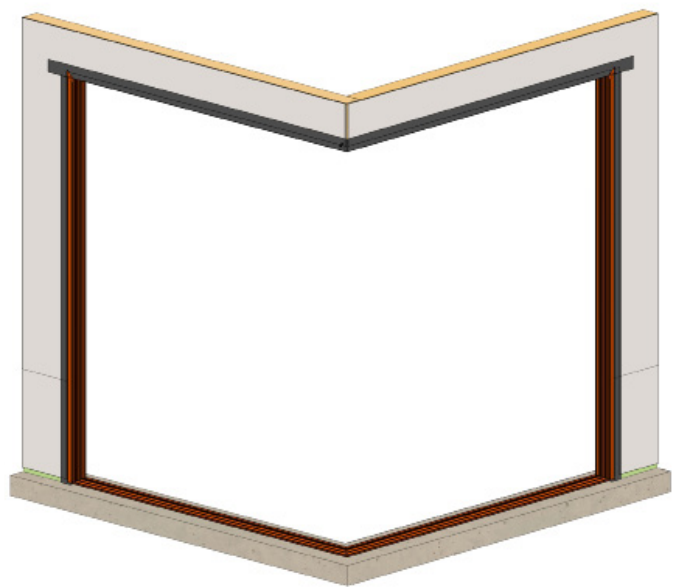

For the other side of the frame repeat steps 25 - 31 prior to moving on.

33

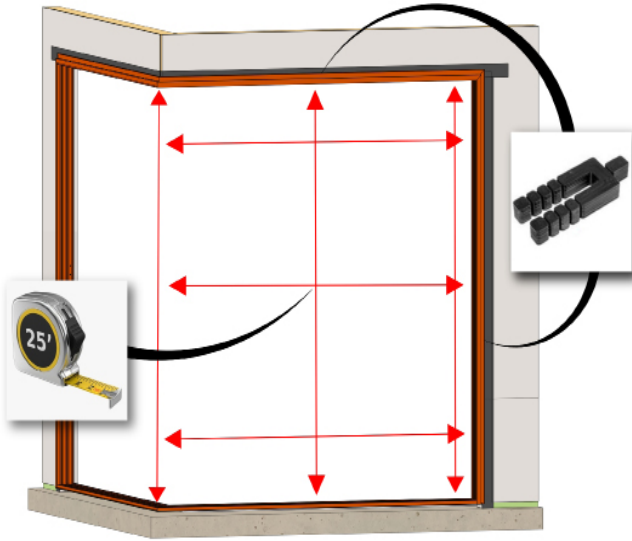

Take other side of the frame and slide it onto the 90 degree keys in the head.

34

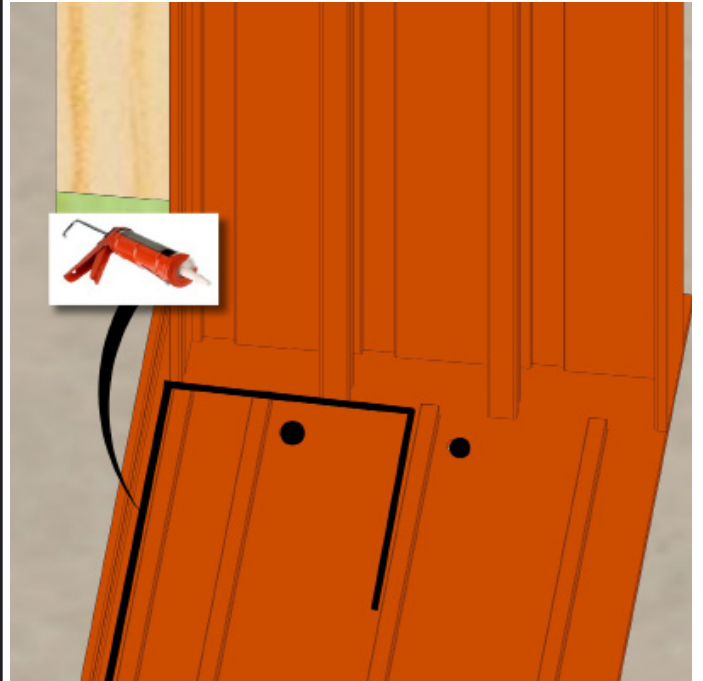

Run a bead of silicone along the wall, up the leg of the flashing pan, and along the interior most lip.  
Note: This will be the space between the lip of the flashing pan and the first leg, as shown above.

35

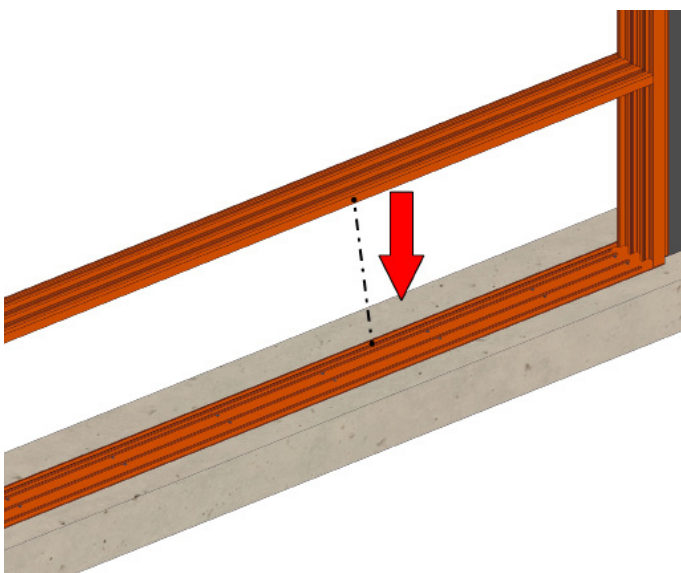

Set the sill in place, and push towards the exterior to lock in the sill to the sill pan.

36

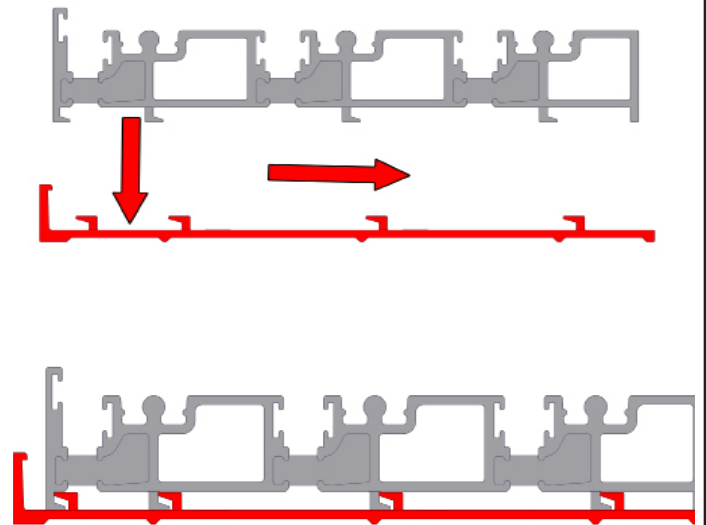

Push the sill down and then toward the exterior to lock in the sill to the sill pan.

37

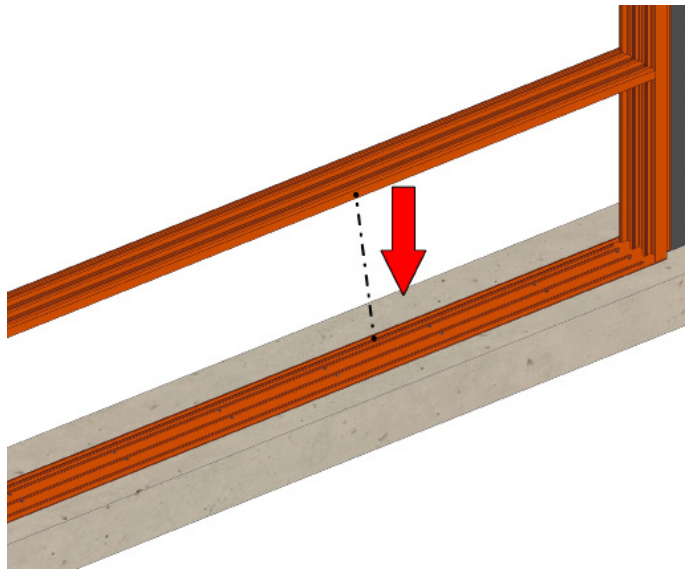

Repeat steps 26 and 27 for the other side before moving on.

38

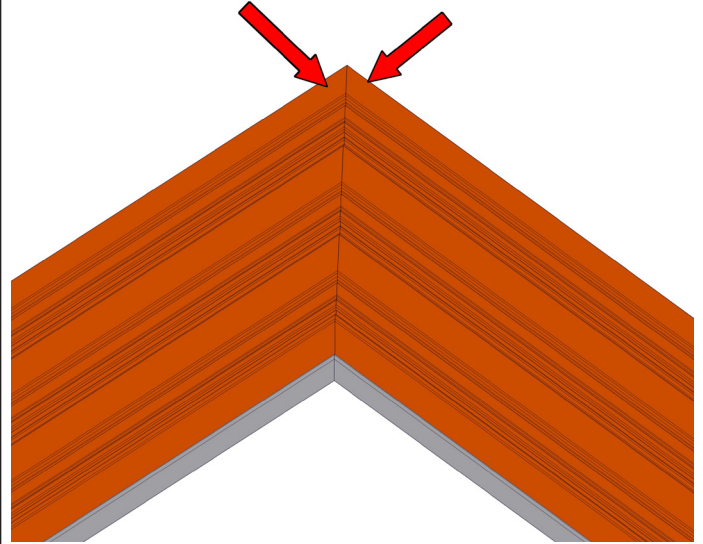

Make sure that there is less than a 1/16" gap between the 2 pieces of sill.

39

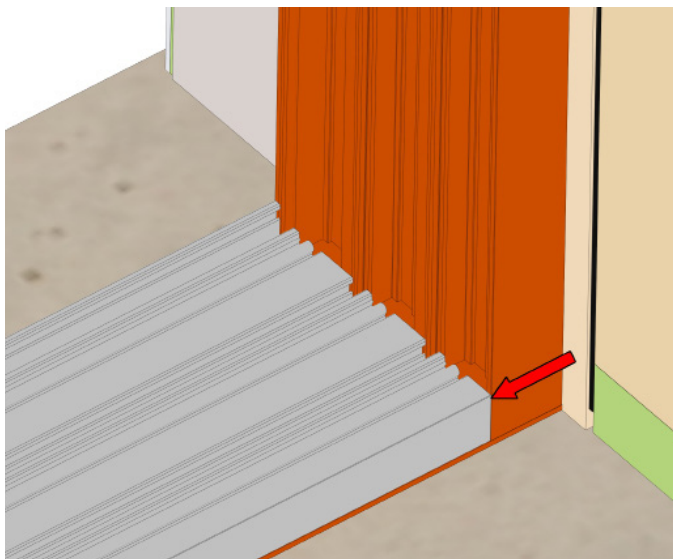

Shim jambs frame to the sill. No more than a 1/16" gap.

40

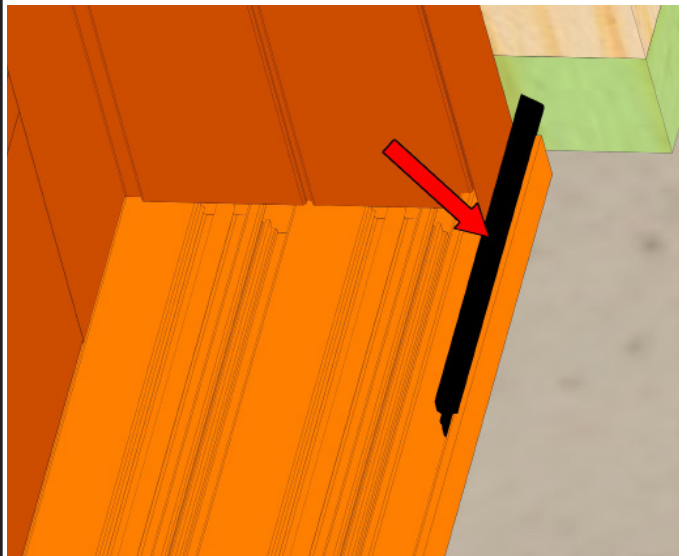

Cut a small piece of wedge gasket and place it in the center, as well as, one piece at each end.

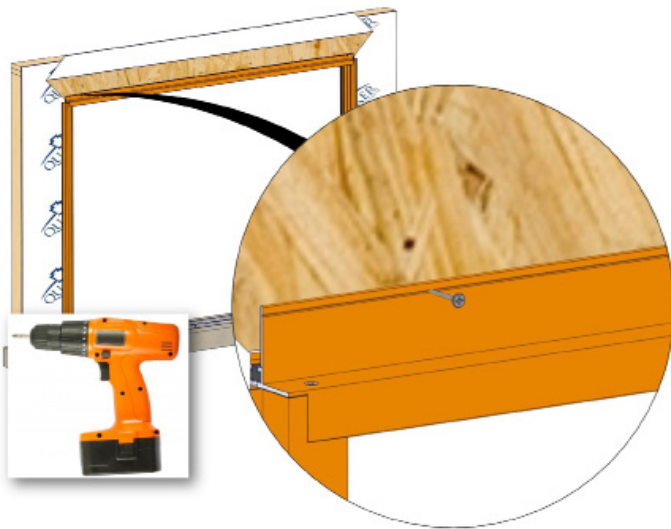

41

**NAIL FIN ONLY!**

Fully fasten the screws down now to hold the frame in place.

42

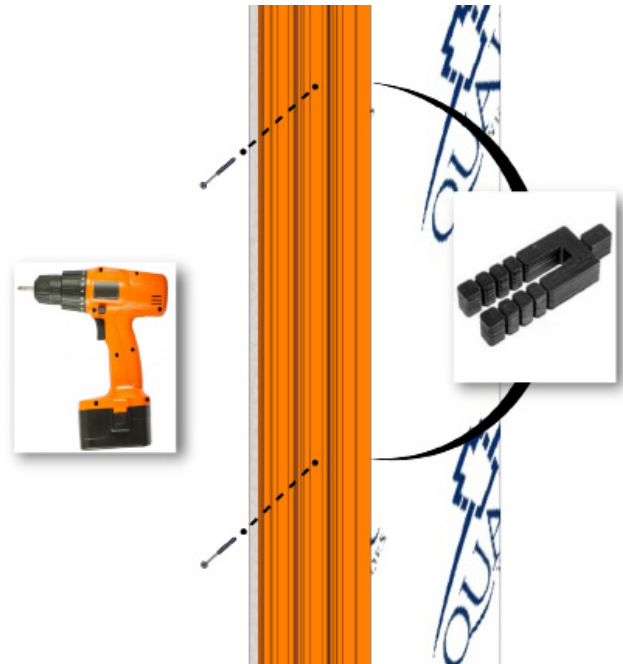

Fully fasten the screws down now to hold the frame in place. The holes through the center track of the header & jambs, typically 6" from ends and 2' on center for fasteners. Shim tight to sill pan.

43

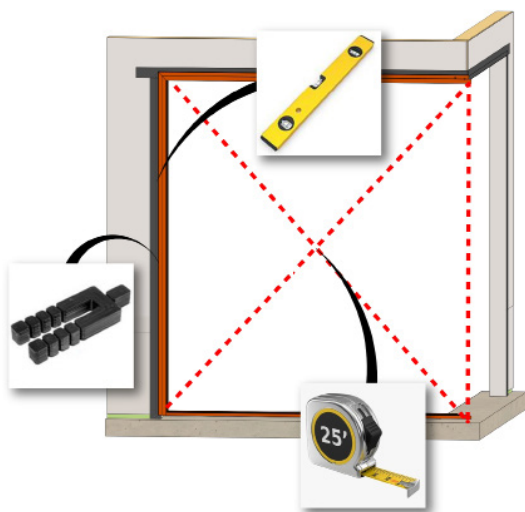

Check that the door frame is not bowed at jambs or head, a string line may be required. The jamb cover can be used to ensure equal spacing between the sill and head. Adjust shims as needed but verify measurements are within 1/16". Repeat for the other side.

44

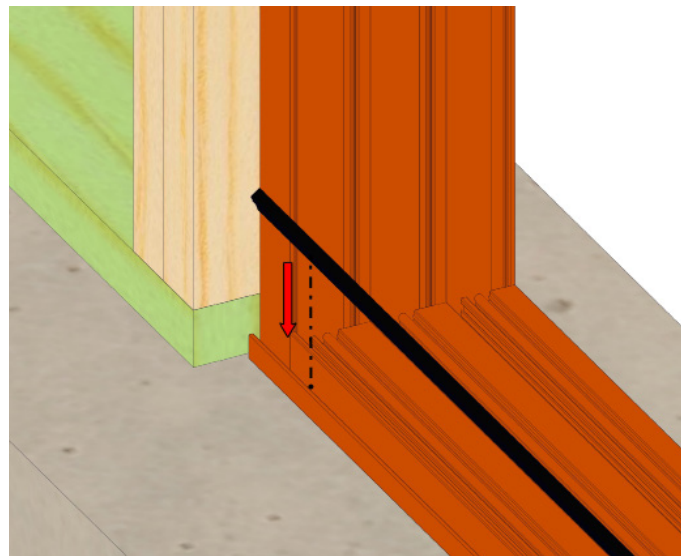

Locate the interior side of the sill. Push the sill down and towards the exterior to lock in place. Take the wedge gasket (Part #: 4874-02-00) and press in place. Note: This will run the whole length of the sill pan.

# PANEL INSTALL

**45**

Inactive Panel

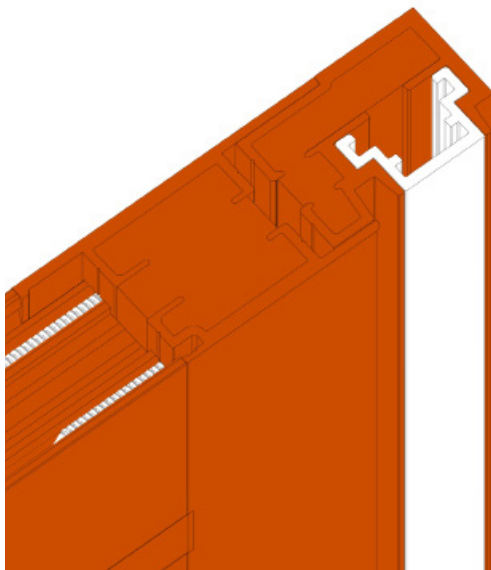

From the exterior, install the inactive panel. This panel will be receiving the active panel. Look for the strike plate.  
 \*Note orientation of interlock rails when choosing panels.  
 \*Note glazing beads are to the interior side.

**46**

Active Panel

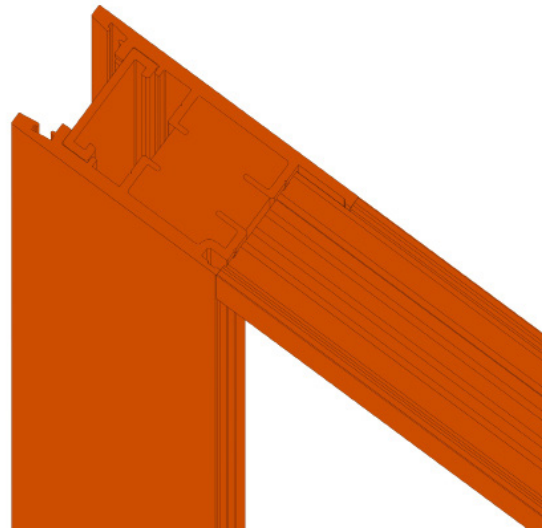

From the exterior, install the active panel. This will lock into the inactive panel. Look for the locking mechanism.  
 \*Note orientation of interlock rails when choosing panels.  
 \*Note glazing beads are to the interior side.



47

Glazing Beads to Interior

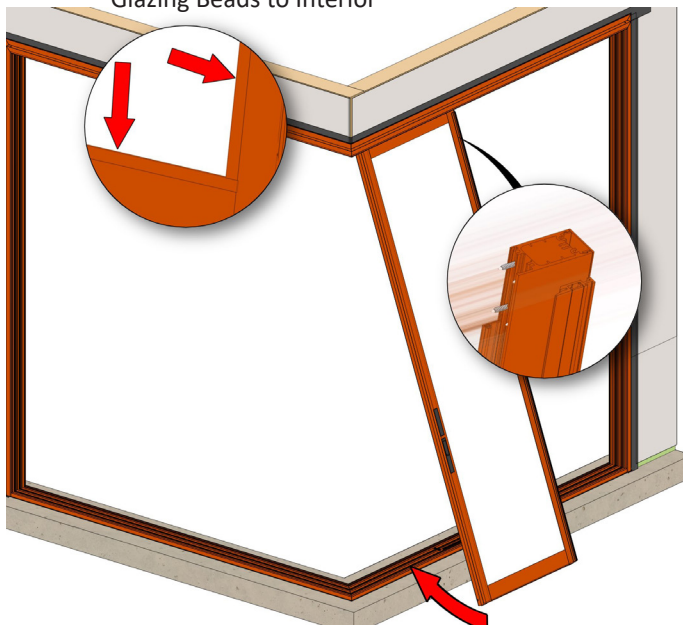

From the exterior, install the locking panel with the handle, by tilting the top into the inner most head track and setting the bottom of the panel in the inner most groove in the sill track.

\*Note orientation of interlock rails when choosing panels.

\*Note glazing beads are to the interior side.

48

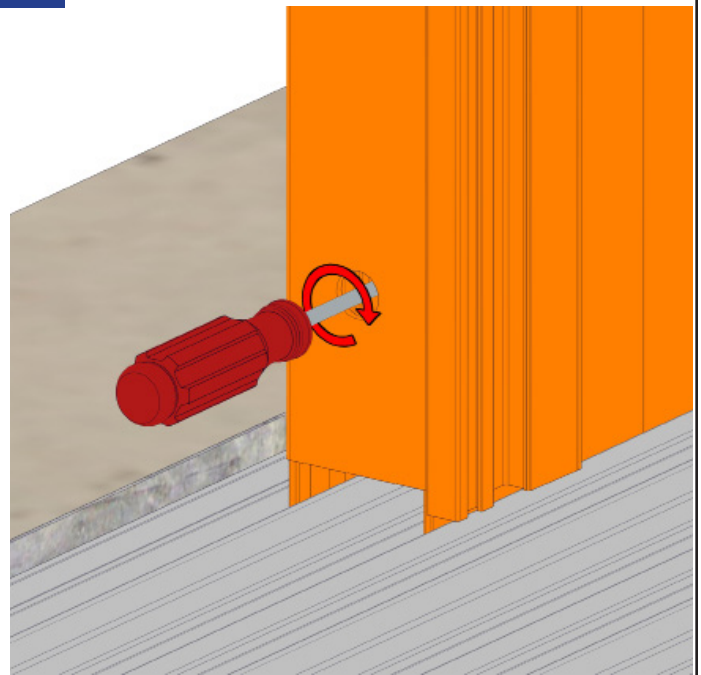

Use a #2 phillips screwdriver to engage the roller adjustment on both sides of a panel. Turn clockwise to raise the panel and provide smooth rolling. If possible, lift the panels slightly when adjusting to take pressure off the rollers. Roll panel back and forth 2-3 times to verify roller height is set.

**Repeat this step for each panel installed.**

49

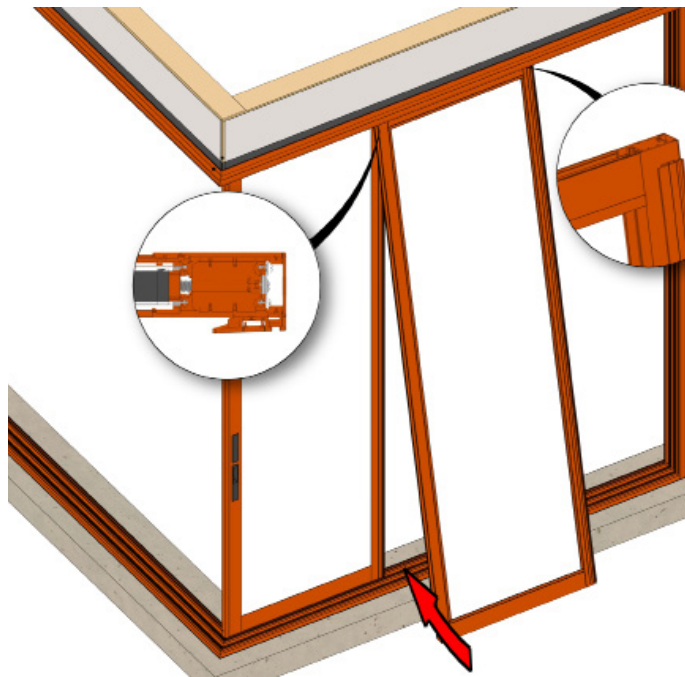

On the exterior side repeat for the middle panel, setting it into the middle tracks in the head and sill. Make sure the panels are overlapped when installing so the interlocks will engage properly.

50

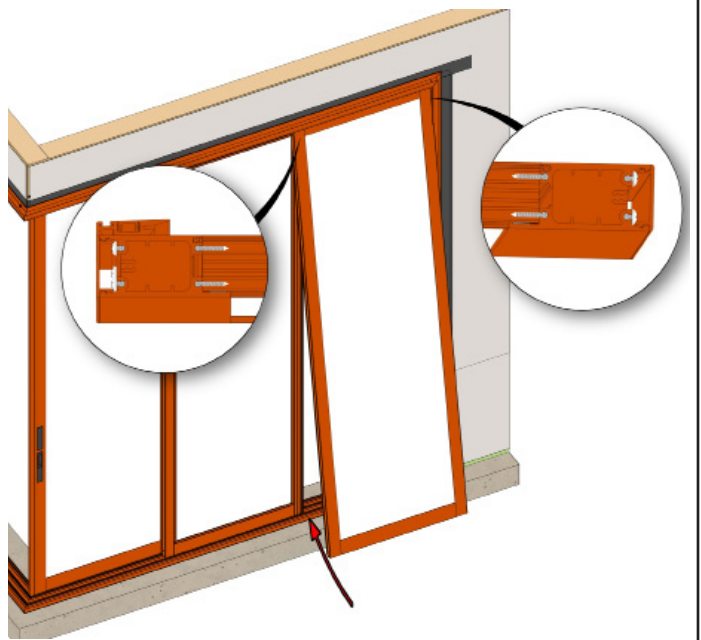

Repeat for exterior panel, setting it into the exterior tracks in the head and sill. Make sure the panels are overlapped when installing so the interlocks will engage properly.

51

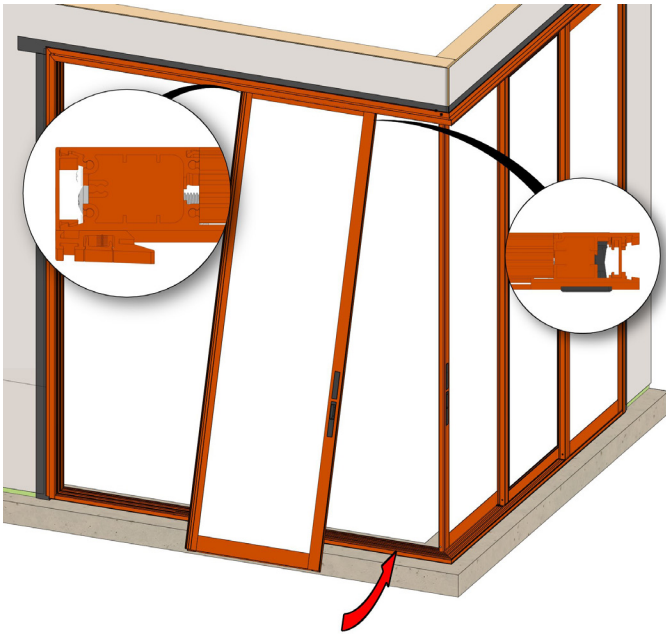

From the exterior, install the locking panel with the handle, by tilting the top into the inner most head track and setting the bottom of the panel in the inner most groove in the sill track.

- \*Note orientation of interlock rails when choosing panels.
- \*Note glazing beads are to the interior side.

52

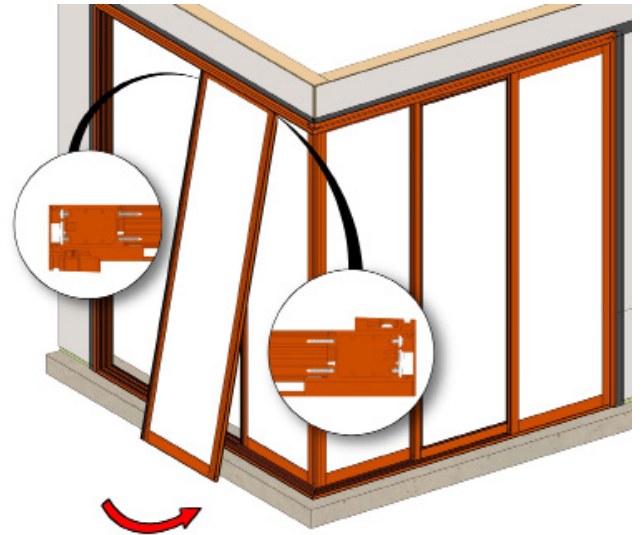

On the exterior side repeat for the middle panel, setting it into the middle tracks in the head and sill. Make sure the panels are overlapped when installing so the interlocks will engage properly.

53

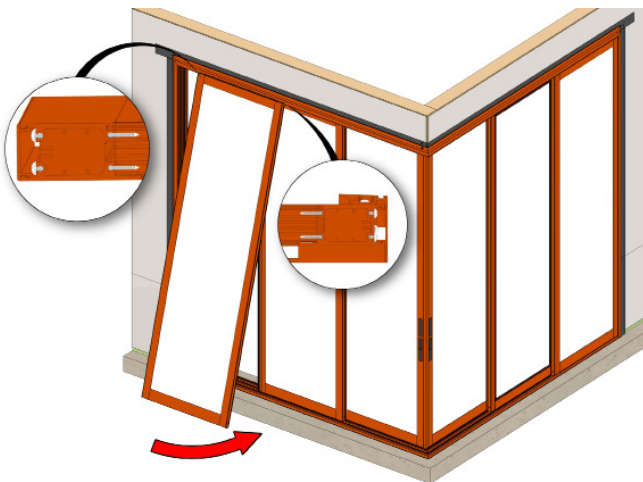

Repeat for exterior panel, setting it into the exterior tracks in the head and sill. Make sure the panels are overlapped when installing so the interlocks will engage properly.

54

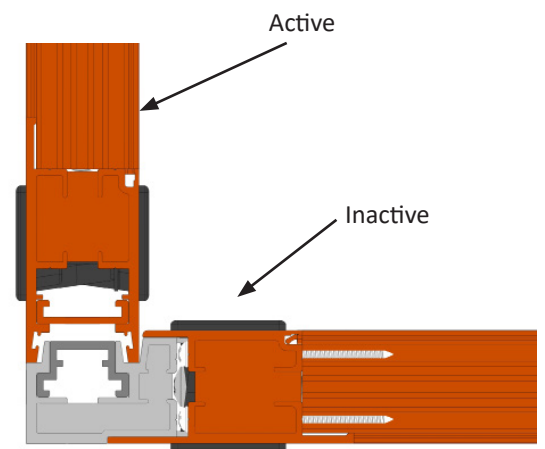

Once all the panels are installed close the panels. Make sure the inactive and active panels lock as shown above.

55



Lock the 2 middle panels together, and adjust rollers on all panels so they roll smoothly. Start with the 2 hardware panels and work your way towards the fixed panels. Check the reveal of the glass at the bottom of panels and adjust as needed to line up all panels.

56

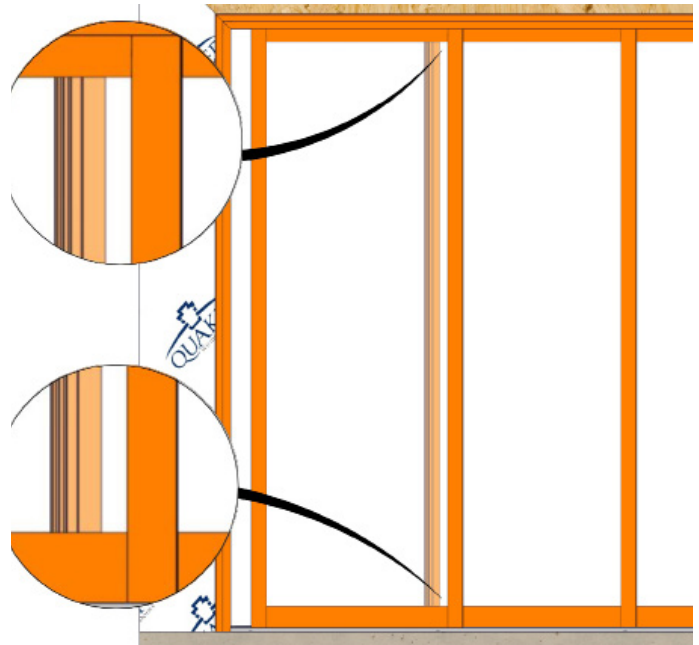

Slide each set of panels apart to check that the reveal matches at the top and bottom. Adjust rollers as needed to match reveal across panels.

57

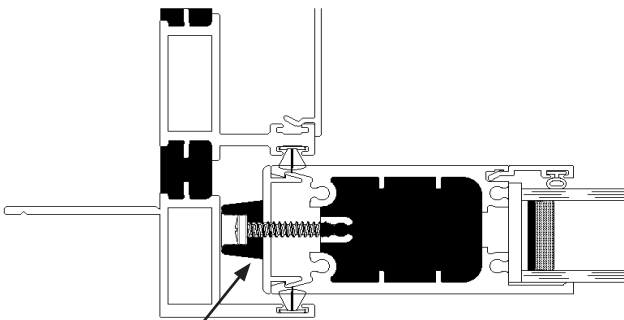

3/8" Panel Spacer

Set the fixed panel 2.5" from the edge of the frame to the edge of the glass of the fixed panel. Be sure the 3/8" panel bumper is installed onto the vinyl prior to sliding jamb into wall.

58

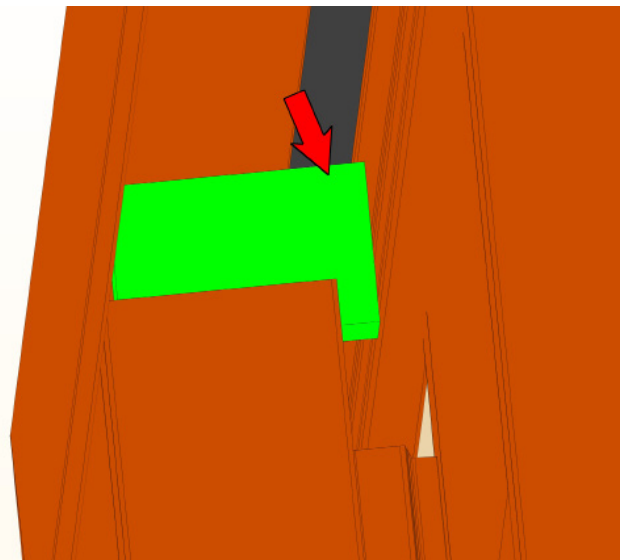

Slide the fix panel fully into the frame jamb, then take the frame head dust plug and remove backing. Slide the dust plug in between the head and the top of the fixed panel. The edge of the panel and the face of the dust plug should be flush. Repeat this step on the other side.

59

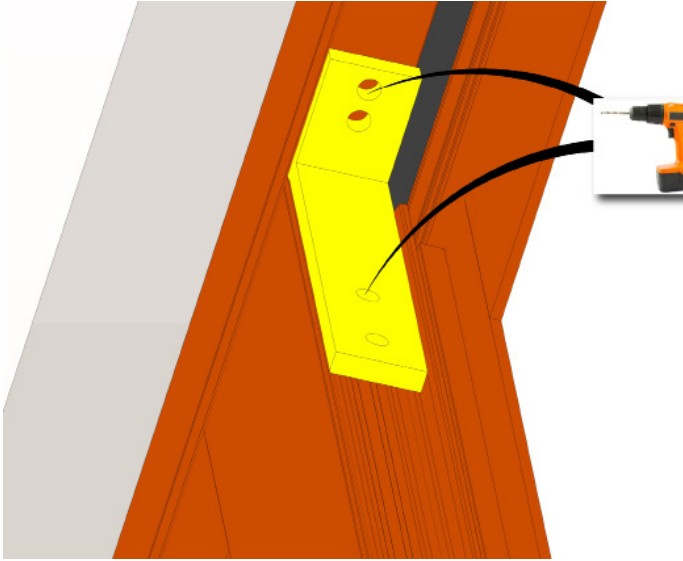

Take the **Fixed Panel Bracket**, slide it to the head drill holes for the tri-wing screws.

60

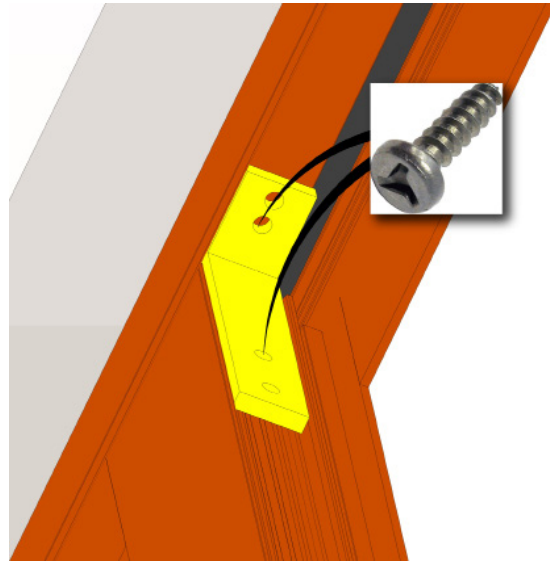

Install the tri-wing screws.

61

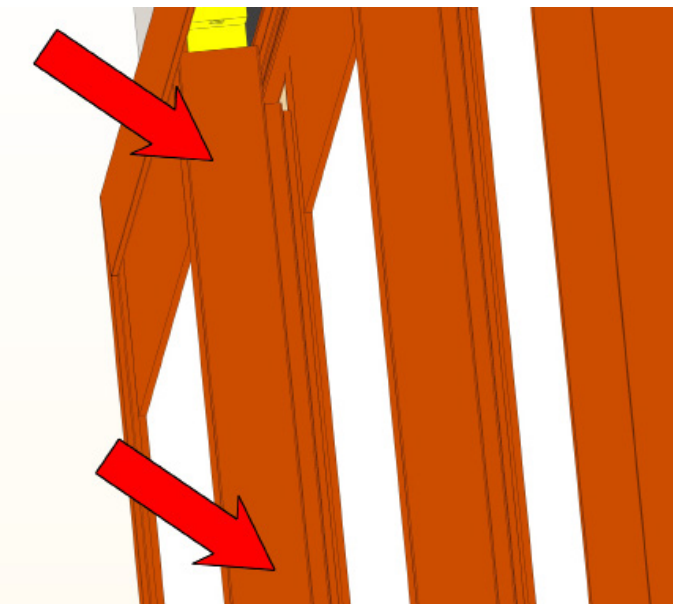

Install the panel cap on the fixed panel frame to cover the fixed panel bracket.  
Make flush with the head.

62

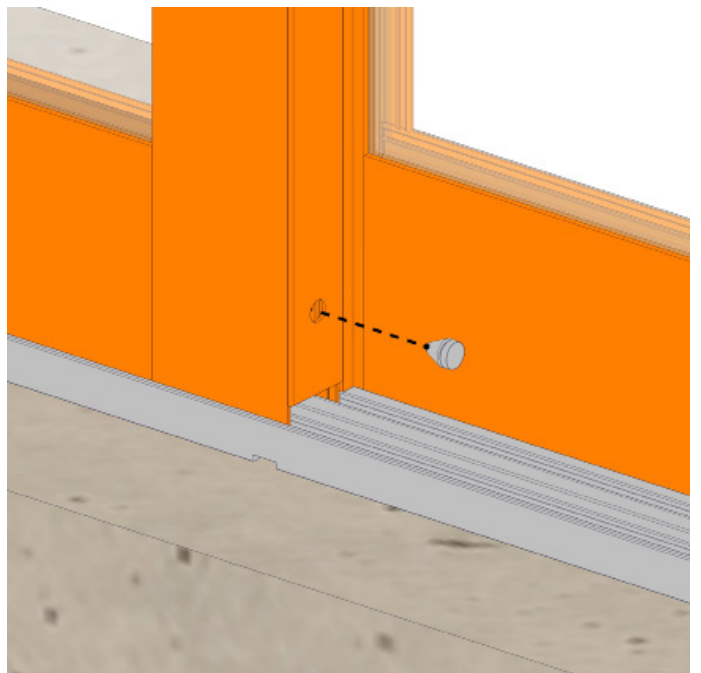

Once all panels have been adjusted install the panel bumpers (Part #: 9309K86) into each roller adjustment hole.

Repeat steps 54-59 for the other side.

63

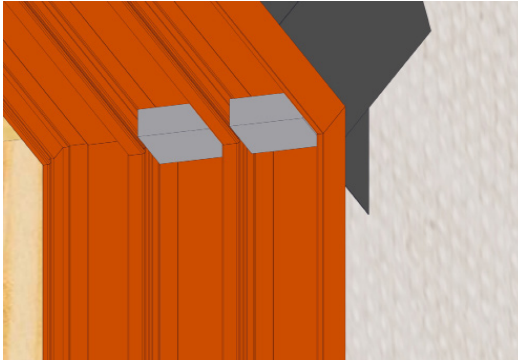

Place 1 dust plug in each track where the heads meet, as shown in the picture above, except the locking panels.

# Frame Covers

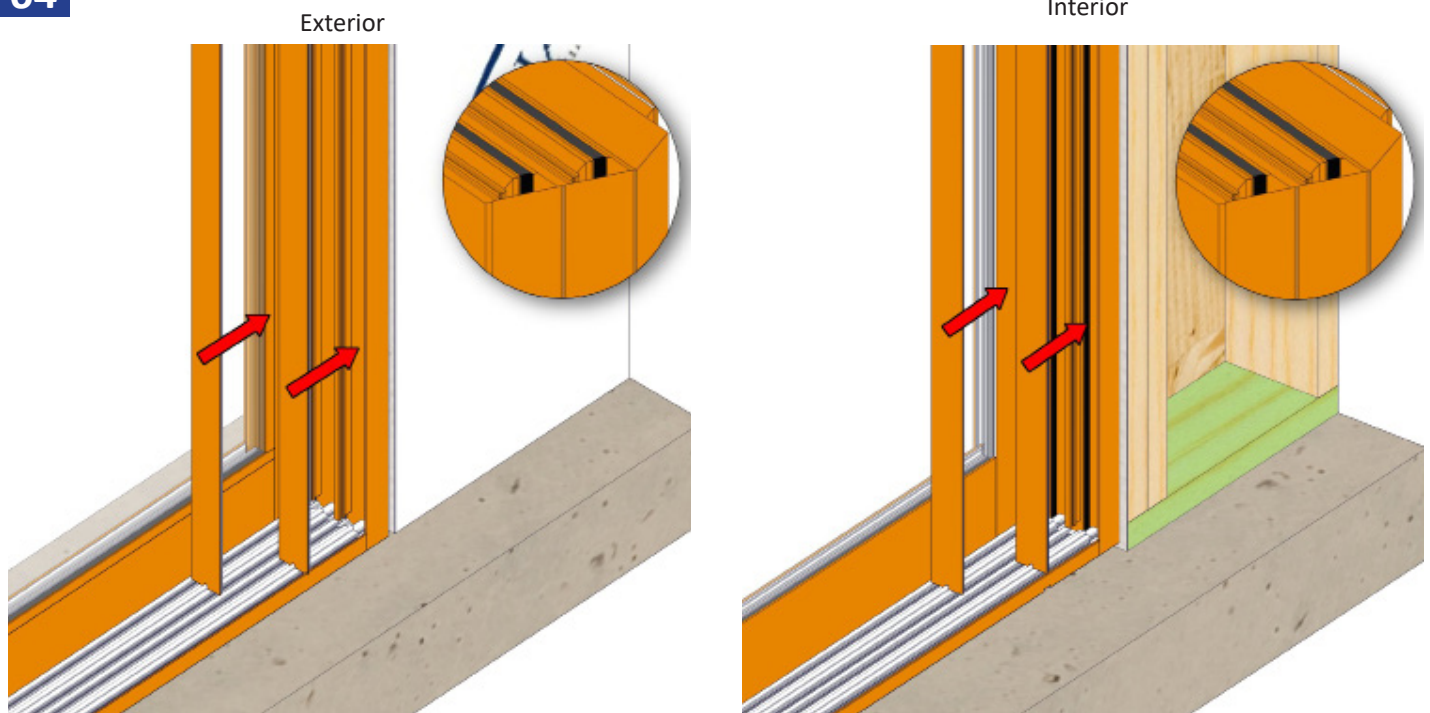

64

**LOCK THE DOOR CLOSED FIRST!**

With rubber mallet, on the exterior jambs of the door, install two frame jamb covers - one in the middle track and one in the outermost track. Repeat for the interior jambs for the middle and most interior jambs. If a mallet is needed to install the jamb covers, use a wood block in between. **DO NOT HIT THE JAMB COVERS DIRECTLY!** Repeat on the other side.

65

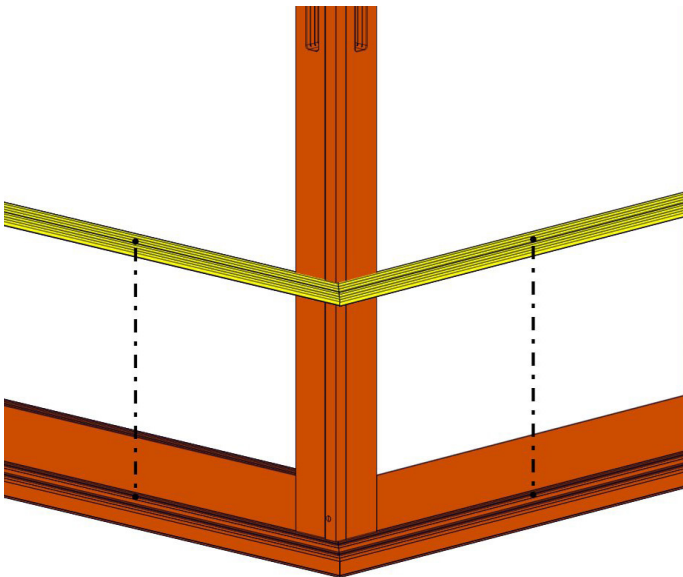

Repeat next steps for both sides. Lay out sill cover before installing, start with the sill cover closer to the interior.

66

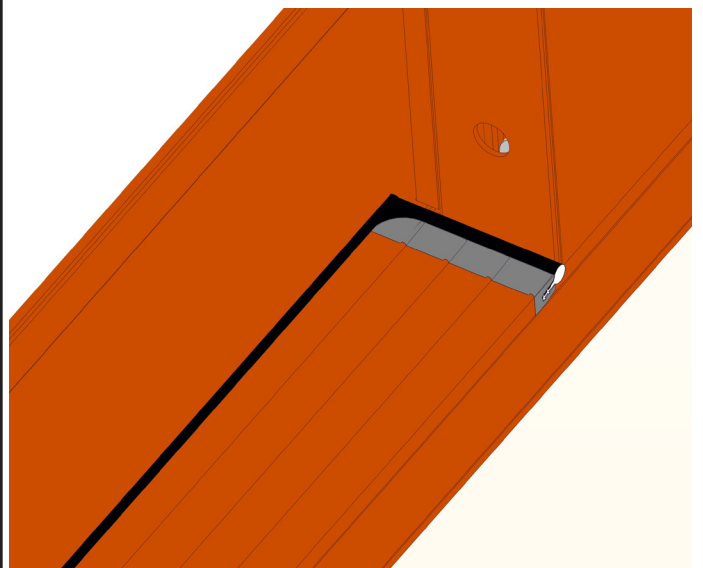

Take the sill covers, and cut the end of the cover that doesn't have the molded part on the end. (Molded part is shown in the picture above in gray.)

67

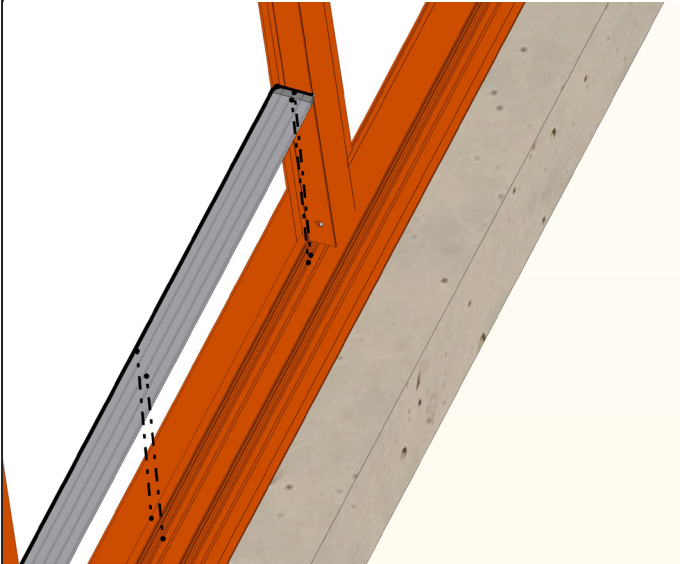

Install the interior sill cover.  
**DO NOT HIT THE SILL COVERS DIRECTLY DURING INSTALL!**  
 NOTE: ON ACTIVE PANEL MEASURE FROM PANEL TO FRAME AND SUBTRACT 1/16", CUT, THEN PLACE AGAINST FRAME.  
 CUT LONG YOU CAN ALWAYS CUT MORE OFF!

68

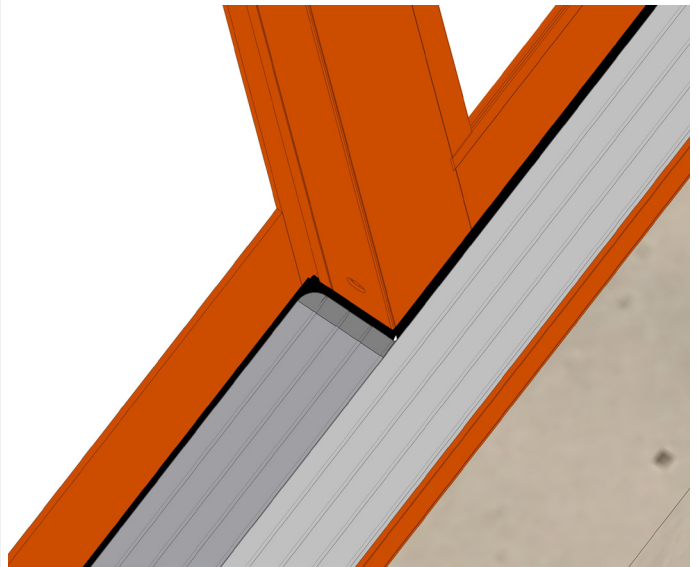

On the exterior sill cover cut out the weather strip where it meets the sill cap you just previously installed.

69

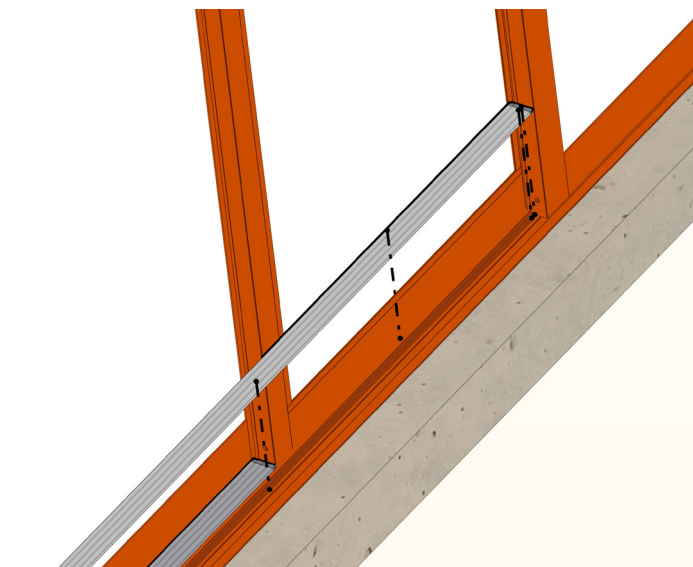

Next install the exterior sill cover.  
**DO NOT HIT THE SILL COVERS DIRECTLY DURING INSTALL!**  
 NOTE: ON ACTIVE PANEL MEASURE FROM PANEL TO FRAME AND SUBTRACT 1/16", CUT, THEN PLACE AGAINST FRAME  
 CUT LONG YOU CAN ALWAYS CUT MORE OFF!  
**REPEAT FOR THE OTHER SIDE.**

70



Next install the short and long header covers in the exterior and middle tracks. Trim covers to fit if needed.  
**DO NOT HIT THE HEADER COVERS DIRECTLY DURING INSTALL!**  
 NOTE: ON ACTIVE PANEL MEASURE FROM PANEL TO FRAME AND SUBTRACT 1/16", CUT, THEN PLACE AGAINST FRAME.  
**REPEAT FOR THE OTHER SIDE.**

# Weather Proofing

71



### Nail fin only.

Apply flashing tape at the sides of the door as shown. Smooth using a J-roller. Extend tape a minimum of 2" past door frame, but not more than the thickness of the flashing tape.

72



Apply a 3/8" sealant bead to the perimeter edge of door frame before installing the drip cap.

Apply flashing tape over the drip cap leg, overlapping the side flashing as shown. Smooth using a J-roller.



**Side flashing cannot extend above the top flashing. Doing so could result in product or property damage.**

73

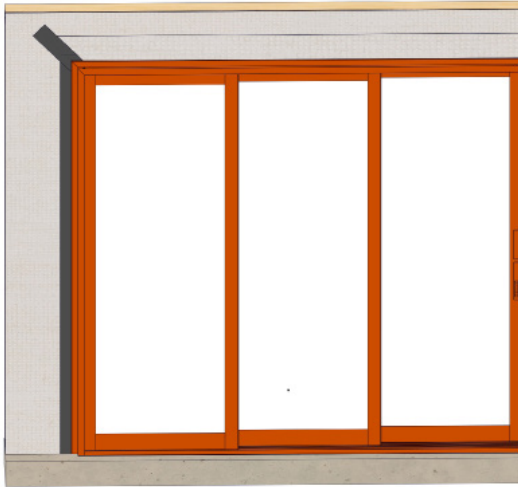

Unfold the house wrap top flap and tape the angled seams as shown.

74

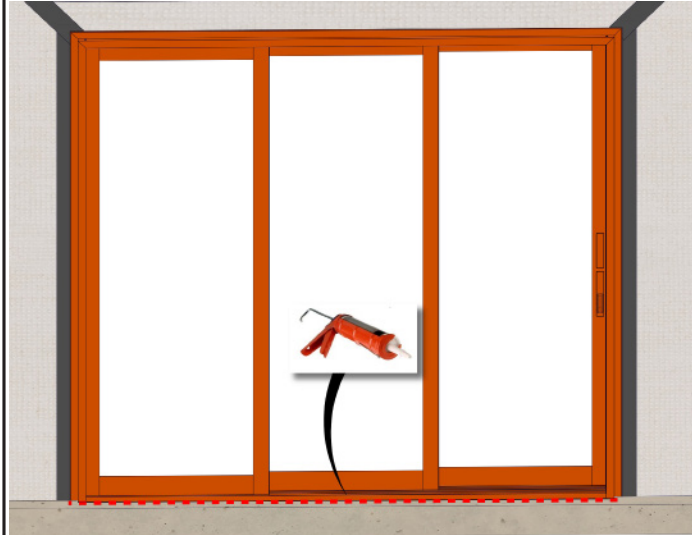

Apply a continuous bead of sealant at the exterior base of the sill. Be sure to not block the weeps on the bottom of the sill.

75



Insulate the gap between the door and framing with minimally expanding spray foam, and seal the entire interior perimeter with sealant.

76

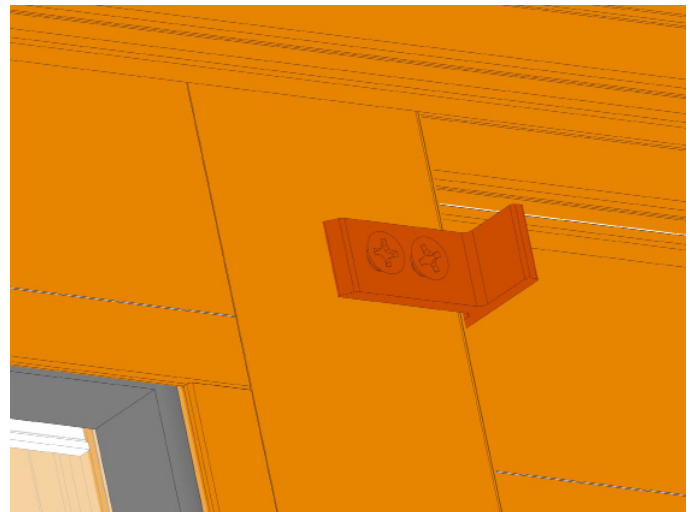

On the interior side of the middle panels, take the panel pickups (Part #: M25296-PCS) and #10 screw (Part #:MF10AX1) that is provided. Take screws and attach the pickups. Install the panel pickup where the holes are already fabricated on the interior side of the door. wd